

# **PHILIPPINE BIDDING DOCUMENTS**

# **Procurement of INFRASTRUCTURE PROJECTS**

Government of the Republic of the Philippines

**PROVISION OF LABOR, MATERIALS,  
EQUIPMENT RENTAL AND OTHER  
INCIDENTALS NEEDED FOR THE  
CONSTRUCTION OF GOAT BREEDER HOUSE  
IN POBLACION WEST, NATIVIDAD,  
PANGASINAN**

**IB No.: DA-RFO 1-2025-INFRA-021**

**Sixth Edition  
July 2020**

# TABLE OF CONTENTS

Glossary of Terms, Abbreviations, and Acronyms .....	4
Section I. Invitation to Bid .....	7
Section II. Instructions to Bidders .....	8
1. <b>Scope of Bid</b> .....	12
2. <b>Funding Information</b> .....	12
3. <b>Bidding Requirements</b> .....	12
4. <b>Corrupt, Fraudulent, Collusive, Coercive, and Obstructive Practices</b> .....	12
5. <b>Eligible Bidders</b> .....	13
6. <b>Origin of Associated Goods</b> .....	13
7. <b>Subcontracts</b> .....	13
8. <b>Pre-Bid Conference</b> .....	13
9. <b>Clarification and Amendment of Bidding Documents</b> .....	13
10. <b>Documents Comprising the Bid: Eligibility and Technical Components</b> .....	14
11. <b>Documents Comprising the Bid: Financial Component</b> .....	14
12. <b>Alternative Bids</b> .....	15
13. <b>Bid Prices</b> .....	15
14. <b>Bid and Payment Currencies</b> .....	15
15. <b>Bid Security</b> .....	15
16. <b>Sealing and Marking of Bids</b> .....	15
17. <b>Deadline for Submission of Bids</b> .....	16
18. <b>Opening and Preliminary Examination of Bids</b> .....	16
19. <b>Detailed Evaluation and Comparison of Bids</b> .....	16
20. <b>Post Qualification</b> .....	16
21. <b>Signing of the Contract</b> .....	17
Section III. Bid Data Sheet .....	18
Section IV. General Conditions of Contract .....	20
1. <b>Scope of Contract</b> .....	21
2. <b>Sectional Completion of Works</b> .....	21
3. <b>Possession of Site</b> .....	21
4. <b>The Contractor's Obligations</b> .....	21
5. <b>Performance Security</b> .....	22
6. <b>Site Investigation Reports</b> .....	22

<b>7. Warranty</b> .....	<b>22</b>
<b>8. Liability of the Contractor</b> .....	<b>22</b>
<b>9. Termination for Other Causes</b> .....	<b>22</b>
<b>10. Dayworks</b> .....	<b>23</b>
<b>11. Program of Work</b> .....	<b>23</b>
<b>12. Instructions, Inspections and Audits</b> .....	<b>23</b>
<b>13. Advance Payment</b> .....	<b>23</b>
<b>14. Progress Payments</b> .....	<b>23</b>
<b>15. Operating and Maintenance Manuals</b> .....	<b>24</b>
<b>Section V. Special Conditions of Contract</b> .....	<b>25</b>
<b>Section VI. Specifications</b> .....	<b>27</b>
<b>Section VII. Drawings</b> .....	<b>28</b>
<b>Section VIII. Bill of Quantities</b> .....	<b>29</b>
<b>Section IX. Checklist of Technical and Financial Documents</b> .....	<b>30</b>

# ***Glossary of Terms, Abbreviations, and Acronyms***

**ABC** – Approved Budget for the Contract.

**ARCC** – Allowable Range of Contract Cost.

**BAC** – Bids and Awards Committee.

**Bid** – A signed offer or proposal to undertake a contract submitted by a bidder in response to and in consonance with the requirements of the bidding documents. Also referred to as *Proposal* and *Tender*. (2016 revised IRR, Section 5[c])

**Bidder** – Refers to a contractor, manufacturer, supplier, distributor and/or consultant who submits a bid in response to the requirements of the Bidding Documents. (2016 revised IRR, Section 5[d])

**Bidding Documents** – The documents issued by the Procuring Entity as the bases for bids, furnishing all information necessary for a prospective bidder to prepare a bid for the Goods, Infrastructure Projects, and/or Consulting Services required by the Procuring Entity. (2016 revised IRR, Section 5[e])

**BIR** – Bureau of Internal Revenue.

**BSP** – Bangko Sentral ng Pilipinas.

**CDA** – Cooperative Development Authority.

**Consulting Services** – Refer to services for Infrastructure Projects and other types of projects or activities of the GOP requiring adequate external technical and professional expertise that are beyond the capability and/or capacity of the GOP to undertake such as, but not limited to: (i) advisory and review services; (ii) pre-investment or feasibility studies; (iii) design; (iv) construction supervision; (v) management and related services; and (vi) other technical services or special studies. (2016 revised IRR, Section 5[i])

**Contract** – Refers to the agreement entered into between the Procuring Entity and the Supplier or Manufacturer or Distributor or Service Provider for procurement of Goods and Services; Contractor for Procurement of Infrastructure Projects; or Consultant or Consulting Firm for Procurement of Consulting Services; as the case may be, as recorded in the Contract Form signed by the parties, including all attachments and appendices thereto and all documents incorporated by reference therein.

**Contractor** – is a natural or juridical entity whose proposal was accepted by the Procuring Entity and to whom the Contract to execute the Work was awarded. Contractor as used in these Bidding Documents may likewise refer to a supplier, distributor, manufacturer, or consultant.

**CPI** – Consumer Price Index.

**DOLE** – Department of Labor and Employment.

**DTI** – Department of Trade and Industry.

**Foreign-funded Procurement or Foreign-Assisted Project** –Refers to procurement whose funding source is from a foreign government, foreign or international financing institution as specified in the Treaty or International or Executive Agreement. (2016 revised IRR, Section 5[b]).

**GFI** – Government Financial Institution.

**GOCC** –Government-owned and/or –controlled corporation.

**Goods** – Refer to all items, supplies, materials and general support services, except Consulting Services and Infrastructure Projects, which may be needed in the transaction of public businesses or in the pursuit of any government undertaking, project or activity, whether in the nature of equipment, furniture, stationery, materials for construction, or personal property of any kind, including non-personal or contractual services such as the repair and maintenance of equipment and furniture, as well as trucking, hauling, janitorial, security, and related or analogous services, as well as procurement of materials and supplies provided by the Procuring Entity for such services. The term “related” or “analogous services” shall include, but is not limited to, lease or purchase of office space, media advertisements, health maintenance services, and other services essential to the operation of the Procuring Entity. (2016 revised IRR, Section 5[r])

**GOP** – Government of the Philippines.

**Infrastructure Projects** – Include the construction, improvement, rehabilitation, demolition, repair, restoration or maintenance of roads and bridges, railways, airports, seaports, communication facilities, civil works components of information technology projects, irrigation, flood control and drainage, water supply, sanitation, sewerage and solid waste management systems, shore protection, energy/power and electrification facilities, national buildings, school buildings, hospital buildings, and other related construction projects of the government. Also referred to as *civil works or works*. (2016 revised IRR, Section 5[u])

**LGUs** – Local Government Units.

**NFCC** – Net Financial Contracting Capacity.

**NGA** – National Government Agency.

**PCAB** – Philippine Contractors Accreditation Board.

**PhilGEPS** - Philippine Government Electronic Procurement System.

**Procurement Project** – refers to a specific or identified procurement covering goods, infrastructure project or consulting services. A Procurement Project shall be described, detailed, and scheduled in the Project Procurement Management Plan prepared by the agency which shall be consolidated in the procuring entity's Annual Procurement Plan. (GPPB Circular No. 06-2019 dated 17 July 2019)

**PSA** – Philippine Statistics Authority.

**SEC** – Securities and Exchange Commission.

**SLCC** – Single Largest Completed Contract.

**UN** – United Nations.

## ***Section I. Invitation to Bid***



Republic of the Philippines  
**DEPARTMENT OF AGRICULTURE**  
 Regional Field Office No. 1  
 Aguila Road, Sevilla, City of San Fernando, La Union  
 Telephone No. (072) 242 1045/1046



**INVITATION TO BID FOR THE PROVISION OF LABOR, MATERIALS, EQUIPMENT RENTAL AND OTHER INCIDENTALS NEEDED FOR THE CONSTRUCTION OF GOAT BREEDER HOUSE IN POBLACION WEST, NATIVIDAD, PANGASINAN**

1. The Department of Agriculture - Regional Field Office 1 (DA-RFO 1), through the GAA FY 2025 intends to apply the sum of **One Million Seven Hundred Thousand Pesos (PhP1,700,000.00)** being the Approved Budget for the Contract (ABC) to payment under the contract for the **PROVISION OF LABOR, MATERIALS, EQUIPMENT RENTAL AND OTHER INCIDENTALS NEEDED FOR THE CONSTRUCTION OF GOAT BREEDER HOUSE IN POBLACION WEST, NATIVIDAD, PANGASINAN** with project identification number **DA-RFO 1-2025-INFRA-021**. Bids received in excess of the ABC shall be automatically rejected at bid opening.
2. The DA-RFO 1 now invites bids for the above procurement project with the following details and specifications:

<b>DETAILS AND SPECIFICATIONS</b>		
<b>Project Location:</b>	Poblacion West, Natividad, Pangasinan	
<b>Project Description:</b>	Construction of Goat breeding House with a dimension of 8x9m for 25 heads of female breeder, at least 5 heads of pregnant and 10m heads of grower	
<b>Scope of work:</b>		
<b>Description</b>	<b>Qty</b>	<b>Unit</b>
I. GENERAL REQUIREMENTS (PERMIT & PROJECT BILLBOARD)	1.00	lot
II. MOBILIZATION AND DEMOBILIZATION	1.00	LS
III. PROVISION OF SAFETY AND HEALTH PROGRAM	1.00	LS
IV. EARTHWORKS	42.57	sq.m.
V. RSB WORKS	3,594.49	kgs
VI. FORM WORKS & SCAFFOLDINGS	520.00	bd.ft.
VII. CONCRETING WORKS	17.12	cu.mtr.
VIII. STEEL WORKS (ROOFING AND RAMP RAILING)	438.00	kgs
IX. TINSMITHRY WORKS	157.20	sq.m.
X. FLOOR, STEEL RAILING AND FEEDING TROUGH WORKS	72.00	sq.m.
XI. PLUMBING WORKS	1.00	lot
XII. PERIMETER FENCE	120.00	mtrs



XIII. ELECTRICAL WORKS	1.00	lot
XIV. MARKER	1.00	lot

**MINIMUM TECHNICAL PERSONNEL REQUIRED:**

- 1 Foreman
- 2 Skilled Workers
- 4 Unskilled Workers

**MINIMUM EQUIPMENT REQUIRED:**

- 1 Welding Machine
- 1 Minor Tool
- 1 Concrete Mixer

Completion of the Works is within **eighty-five (85) calendar days**. Bidders should have completed a contract similar to the Project. The description of an eligible bidder is contained in the Bidding Documents, particularly, in Section II. (Instructions to Bidders).

3. Bidding will be conducted through open competitive bidding procedures using a non-discretionary “pass/fail” criterion as specified in the Implementing Rules and Regulations (IRR) of Republic Act (RA) 9184.

Bidding is restricted to Filipino citizens/sole proprietorships, partnerships, or organizations with at least seventy-five percent (75%) interest or outstanding capital stock belonging to citizens of the Philippines.

4. Prospective bidders may obtain further information from and inspect the Bidding Documents at the address given below during **office hours at 8:00 AM to 5:00 PM, Monday to Friday**.

**Department of Agriculture - Regional Field Office 1  
Aguila Rd., Sevilla, City of San Fernando, La Union**

5. A complete set of Bidding Documents may be acquired by interested Bidders from **February 5-26, 2025** from the address given and websites below and upon payment of the applicable fee for the Bidding Documents, pursuant to the latest Guidelines issued by the GPPB, in the amount of **PhP5,000.00**. The Procuring Entity shall allow the bidder to present its proof of payment for the fees in person, by facsimile, or through electronic means.
6. The **DA-RFO 1** will hold a Pre-Bid Conference on **12 February 2025, 10:00 AM** at DA-RFO 1, 5<sup>th</sup> Floor Conference Room, Aguila Road, Sevilla, City of San Fernando, La Union, which shall be open to prospective bidders.
7. Bids must be duly received by the BAC Secretariat through manual submission at the office address indicated above on or before **26 February 2025, 10:00 AM. Late bids shall not be accepted.**
8. All bids must be accompanied by a bid security in any of the acceptable forms and in the amount stated in **ITB** Clause 14.
9. **Bid opening** shall be on **26 February 2025, 10:00 AM** at DA-RFO 1, 5th Floor Conference Room, Aguila Road, Sevilla, City of San Fernando, La Union. Bids will be opened in the presence of the bidders or their authorized representatives.

**10. ADDITIONAL INSTRUCTIONS TO BIDDERS:**

- a. The bidders or their duly authorized representatives may attend the bid opening;
- b. In case a representative will be attending the Bid Opening, a Special Power of Attorney (SPA), Secretary's Certificate, Board Resolution or any other forms of authorization (notarized), as the case may be, together with the Company-issued Identification Card or any valid ID must be presented upon submission of the bid proposal at the BAC Secretariat. The name/title of the project must be indicated in the authorization or SPA.
- c. Each Bidder shall submit one copy of the first and second components of its Bid. Bidders shall submit their bids with proper index tabbing using the forms specified in the Bidding Documents in two (2) separate sealed bid envelopes, and which shall be submitted simultaneously;

The first component which is the Technical Eligibility requirements must be soft-bound, marked with the **name of the contract** and its **IB No., name and address of the bidder**, and enclosed in an envelope, sealed with signature and marked with the **name of the contract, name and address of the bidder**, addressed to the **BIDS AND AWARDS COMMITTEE (BAC) DA RFO-1 CITY OF SAN FERNANDO, LA UNION**, the **specific Identification No.** and the warning **"DO NOT OPEN BEFORE..."** the date and time for the bid opening.

The second component being the Financial requirements may be soft-bound/fastened in a folder, marked with the **name of the contract** and its **IB No., name and address of the bidder**, and enclosed in an envelope, sealed with signature and marked with the **name of the contract, name and address of the bidder**, addressed to the **BIDS AND AWARDS COMMITTEE (BAC) DA RFO-1 CITY OF SAN FERNANDO, LA UNION**, the **specific Identification No.** and the warning **"DO NOT OPEN BEFORE..."** the date and time for the bid opening.

The Technical and Financial Requirement each in separate envelopes, shall be enclosed in a mother envelope with the same sealing and markings.

Non-compliance with index tabbings shall not be a ground for outright disqualification or declaration of ineligibility. The improper index tabbings must be duly acknowledged by the bidder/representative and be subject to the bid evaluation and post-qualification of the Technical Working Group (TWG) as to their substance.

- d. All **documents** in the **Financial Requirements envelope** must be **duly signed and/or initialed**, as needed, by the bidder/authorized representative on **EACH AND EVERY PAGE** thereof.
11. The **DA-RFO 1** reserves the right to reject any and all bids, declare a failure of bidding, or not award the contract at any time prior to contract award in accordance with Sections 35.6 and Section 41 of the 2016 Revised IRR of RA No. 9184, without thereby incurring any liability to the affected bidder or bidders.

12. For further information, please refer to:

**DENNIS I. TACTAC, ABE**

*Chairperson, Bids and Awards Committee*

**Department of Agriculture - Regional Field Office 1**

Aguila Road, Sevilla, City of San Fernando, La Union

Tel. No.:(072) 242/1045-46, Ext. 07

E-mail add: [bacsec@ilocos.da.gov.ph](mailto:bacsec@ilocos.da.gov.ph)

13. For downloading of Bidding Documents, you may visit the following websites:

DA-RFO1 Website: <https://ilocos.da.gov.ph/>

PhilGEPS Website: <https://www.philgeps.gov.ph/>

February 4, 2025

**Approved by:**

**(Sgd.) GILBERT D. RABARA, DVM**

*Vice-Chairperson, Bids and Awards Committee*

**Invitation to Bid Identification No. DA-RFO 1-2025-INFRA-021**

## ***Section II. Instructions to Bidders***

### **1. Scope of Bid**

The Procuring Entity, **Department of Agriculture - Regional Field Office 1 (DA-RFO 1)** invites Bids for the **PROVISION OF LABOR, MATERIALS, EQUIPMENT RENTAL AND OTHER INCIDENTALS NEEDED FOR THE CONSTRUCTION OF GOAT BREEDER HOUSE IN POBLACION WEST, NATIVIDAD, PANGASINAN** with Project Identification Number **DA-RFO 1-2025-INFRA-021**.

The Procurement Project (referred to herein as “Project”) is for the construction of Works, as described in Section VI (Specifications).

### **2. Funding Information**

**2.1.** The GOP through the source of funding as indicated below for **GAA FY 2025** in the amount of **One Million Seven Hundred Thousand Pesos (PhP1,700,000.00)**.

### **3. Bidding Requirements**

The Bidding for the Project shall be governed by all the provisions of RA No. 9184 and its 2016 revised IRR, including its Generic Procurement Manual and associated policies, rules and regulations as the primary source thereof, while the herein clauses shall serve as the secondary source thereof.

Any amendments made to the IRR and other GPPB issuances shall be applicable only to the ongoing posting, advertisement, or invitation to bid by the BAC through the issuance of a supplemental or bid bulletin.

The Bidder, by the act of submitting its Bid, shall be deemed to have inspected the site, determined the general characteristics of the contracted Works and the conditions for this Project, such as the location and the nature of the work; (b) climatic conditions; (c) transportation facilities; (c) nature and condition of the terrain, geological conditions at the site communication facilities, requirements, location and availability of construction aggregates and other materials, labor, water, electric power and access roads; and (d) other factors that may affect the cost, duration and execution or implementation of the contract, project, or work and examine all instructions, forms, terms, and project requirements in the Bidding Documents.

### **4. Corrupt, Fraudulent, Collusive, Coercive, and Obstructive Practices**

The Procuring Entity, as well as the Bidders and Contractors, shall observe the highest standard of ethics during the procurement and execution of the contract. They or through an agent shall not engage in corrupt, fraudulent, collusive, coercive, and obstructive practices defined under Annex “I” of the 2016 revised IRR of RA No. 9184 or other integrity violations in competing for the Project.

## 5. Eligible Bidders

- 5.1. Only Bids of Bidders found to be legally, technically, and financially capable will be evaluated.
- 5.2. The Bidder must have an experience of having completed a Single Largest Completed Contract (SLCC) that is similar to this Project, equivalent to at least fifty percent (50%) of the ABC adjusted, if necessary, by the Bidder to current prices using the PSA's CPI, except under conditions provided for in Section 23.4.2.4 of the 2016 revised IRR of RA No. 9184.  
  
A contract is considered to be "similar" to the contract to be bid if it has the major categories of work stated in the **BDS**.
- 5.3. For Foreign-funded Procurement, the Procuring Entity and the foreign government/foreign or international financing institution may agree on another track record requirement, as specified in the Bidding Document prepared for this purpose.
- 5.4. The Bidders shall comply with the eligibility criteria under Section 23.4.2 of the 2016 IRR of RA No. 9184.

## 6. Origin of Associated Goods

There is no restriction on the origin of Goods other than those prohibited by a decision of the UN Security Council taken under Chapter VII of the Charter of the UN.

## 7. Subcontracts

- 7.1. The Bidder may subcontract portions of the Project to the extent allowed by the Procuring Entity as stated herein, but in no case more than fifty percent (50%) of the Project.

The Procuring Entity has prescribed that subcontracting is not allowed:

## 8. Pre-Bid Conference

The Procuring Entity will hold a pre-bid conference for this Project on the specified date and time and either at its physical address, **5<sup>th</sup> Floor Conference Room, Aguila Road, Sevilla, City of San Fernando, La Union** indicated in paragraph 6 of the **IB**.

## 9. Clarification and Amendment of Bidding Documents

Prospective bidders may request for clarification on and/or interpretation of any part of the Bidding Documents. Such requests must be in writing and received by the Procuring Entity, either at its given address or through electronic mail indicated in the **IB**, at least ten (10) calendar days before the deadline set for the submission and receipt of Bids.

## **10. Documents Comprising the Bid: Eligibility and Technical Components**

- 10.1. The first envelope shall contain the eligibility and technical documents of the Bid as specified in **Section IX. Checklist of Technical and Financial Documents**.
- 10.2. If the eligibility requirements or statements, the bids, and all other documents for submission to the BAC are in foreign language other than English, it must be accompanied by a translation in English, which shall be authenticated by the appropriate Philippine foreign service establishment, post, or the equivalent office having jurisdiction over the foreign bidder's affairs in the Philippines. For Contracting Parties to the Apostille Convention, only the translated documents shall be authenticated through an apostille pursuant to GPPB Resolution No. 13-2019 dated 23 May 2019. The English translation shall govern, for purposes of interpretation of the bid.
- 10.3. A valid PCAB License is required, and in case of joint ventures, a valid special PCAB License, and registration for the type and cost of the contract for this Project. Any additional type of Contractor license or permit shall be indicated in the **BDS**.
- 10.4. A List of Contractor's key personnel (e.g., Project Manager, Project Engineers, Materials Engineers, and Foremen) assigned to the contract to be bid, with their complete qualification and experience data shall be provided. These key personnel must meet the required minimum years of experience set in the **BDS**.
- 10.5. A List of Contractor's major equipment units, which are owned, leased, and/or under purchase agreements, supported by proof of ownership, certification of availability of equipment from the equipment lessor/vendor for the duration of the project, as the case may be, must meet the minimum requirements for the contract set in the **BDS**.

## **11. Documents Comprising the Bid: Financial Component**

- 11.1. The second bid envelope shall contain the financial documents for the Bid as specified in **Section IX. Checklist of Technical and Financial Documents**.
- 11.2. Any bid exceeding the ABC indicated in paragraph 1 of the **IB** shall not be accepted.
- 11.3. For Foreign-funded procurement, a ceiling may be applied to bid prices provided the conditions are met under Section 31.2 of the 2016 revised IRR of RA No. 9184.

## 12. Alternative Bids

Bidders shall submit offers that comply with the requirements of the Bidding Documents, including the basic technical design as indicated in the drawings and specifications. Unless there is a value engineering clause in the **BDS**, alternative Bids shall not be accepted.

## 13. Bid Prices

All bid prices for the given scope of work in the Project as awarded shall be considered as fixed prices, and therefore not subject to price escalation during contract implementation, except under extraordinary circumstances as determined by the NEDA and approved by the GPPB pursuant to the revised Guidelines for Contract Price Escalation guidelines.

## 14. Bid and Payment Currencies

14.1. Bid prices may be quoted in the local currency or tradeable currency accepted by the BSP at the discretion of the Bidder. However, for purposes of bid evaluation, Bids denominated in foreign currencies shall be converted to Philippine currency based on the exchange rate as published in the BSP reference rate bulletin on the day of the bid opening.

14.2. *Payment of the contract price shall be made in:*

- a. Philippine Pesos.

## 15. Bid Security

15.1. The Bidder shall submit a Bid Securing Declaration or any form of Bid Security in the amount indicated in the **BDS**, which shall be not less than the percentage of the ABC in accordance with the schedule in the **BDS**.

15.2. The Bid and bid security shall be valid until **June 26, 2025**. Any bid not accompanied by an acceptable bid security shall be rejected by the Procuring Entity as non-responsive.

## 16. Sealing and Marking of Bids

Each Bidder shall submit one copy of the first and second components of its Bid.

The Procuring Entity may request additional hard copies and/or electronic copies of the Bid. However, failure of the Bidders to comply with the said request shall not be a ground for disqualification.

If the Procuring Entity allows the submission of bids through online submission to the given website or any other electronic means, the Bidder shall submit an electronic copy of its Bid, which must be digitally signed. An electronic copy that cannot be

opened or is corrupted shall be considered non-responsive and, thus, automatically disqualified.

## **17. Deadline for Submission of Bids**

The Bidders shall submit on the specified date and time and either at its physical address or through online submission as indicated in paragraph 7 of the **IB**.

## **18. Opening and Preliminary Examination of Bids**

18.1. The BAC shall open the Bids in public at the time, on the date, and at the place specified in paragraph 9 of the **IB**. The Bidders' representatives who are present shall sign a register evidencing their attendance. In case videoconferencing, webcasting or other similar technologies will be used, attendance of participants shall likewise be recorded by the BAC Secretariat.

In case the Bids cannot be opened as scheduled due to justifiable reasons, the rescheduling requirements under Section 29 of the 2016 revised IRR of RA No. 9184 shall prevail.

18.2. The preliminary examination of Bids shall be governed by Section 30 of the 2016 revised IRR of RA No. 9184.

## **19. Detailed Evaluation and Comparison of Bids**

19.1. The Procuring Entity's BAC shall immediately conduct a detailed evaluation of all Bids rated "*passed*" using non-discretionary pass/fail criteria. The BAC shall consider the conditions in the evaluation of Bids under Section 32.2 of 2016 revised IRR of RA No. 9184.

19.2. If the Project allows partial bids, all Bids and combinations of Bids as indicated in the **BDS** shall be received by the same deadline and opened and evaluated simultaneously so as to determine the Bid or combination of Bids offering the lowest calculated cost to the Procuring Entity. Bid Security as required by **ITB** Clause 15 shall be submitted for each contract (lot) separately.

19.3. In all cases, the NFCC computation pursuant to Section 23.4.2.6 of the 2016 revised IRR of RA No. 9184 must be sufficient for the total of the ABCs for all the lots participated in by the prospective Bidder.

## **20. Post Qualification**

Within a non-extendible period of five (5) calendar days from receipt by the Bidder of the notice from the BAC that it submitted the Lowest Calculated Bid, the Bidder shall submit its latest income and business tax returns filed and paid through the BIR Electronic Filing and Payment System (eFPS), and other appropriate licenses and permits required by law and stated in the **BDS**.



## **21. Signing of the Contract**

The documents required in Section 37.2 of the 2016 revised IRR of RA No. 9184 shall form part of the Contract. Additional Contract documents are indicated in the **BDS**.

## ***Section III. Bid Data Sheet***

# Bid Data Sheet

ITB Clause													
5.2	For this purpose, contracts similar to the Project refer to contracts which have the same major categories of work, which shall be: <b>CONSTRUCTION OF GOAT HOUSE OR ANY RELATED ANIMAL HOUSING STRUCTURE</b>												
7.1	N/A												
10.3	N/A												
10.4	The key personnel must meet the required minimum years of experience set below: <table border="1" style="margin-left: auto; margin-right: auto;"> <thead> <tr> <th style="text-align: center;">Key Personnel</th> <th style="text-align: center;">General Experience</th> <th style="text-align: center;">Relevant Experience</th> </tr> </thead> <tbody> <tr> <td style="text-align: center;">Foreman</td> <td style="text-align: center;">2 years</td> <td style="text-align: center;">Masonry/Carpentry</td> </tr> </tbody> </table>	Key Personnel	General Experience	Relevant Experience	Foreman	2 years	Masonry/Carpentry						
Key Personnel	General Experience	Relevant Experience											
Foreman	2 years	Masonry/Carpentry											
10.5	The minimum major equipment requirements are the following: <table border="1" style="margin-left: auto; margin-right: auto;"> <thead> <tr> <th style="text-align: center;">Equipment</th> <th style="text-align: center;">Capacity</th> <th style="text-align: center;">No. of Units</th> </tr> </thead> <tbody> <tr> <td style="text-align: center;">Welding Machine</td> <td></td> <td style="text-align: center;">1</td> </tr> <tr> <td style="text-align: center;">Minor Tool</td> <td></td> <td style="text-align: center;">1</td> </tr> <tr> <td style="text-align: center;">Concrete Mixer</td> <td></td> <td style="text-align: center;">1</td> </tr> </tbody> </table>	Equipment	Capacity	No. of Units	Welding Machine		1	Minor Tool		1	Concrete Mixer		1
Equipment	Capacity	No. of Units											
Welding Machine		1											
Minor Tool		1											
Concrete Mixer		1											
12	N/A												
15.1	The bid security shall be in the form of a Bid Securing Declaration or any of the following forms and amounts: <p style="margin-left: 40px;">a. The amount of not less than <b>Php34,000.00</b> bid security is in cash, cashier's/manager's check, bank draft/guarantee or irrevocable letter of credit;</p> <p style="margin-left: 40px;">b. The amount of not less than <b>Php85,000.00</b> bid security is in Surety Bond.</p>												
19.2	Partial bidis not allowed.												
20	Latest income and business tax returns filed and paid through the BIR Electronic Filing and Payment System (eFPS) and other appropriate licenses and permits required by law.												
21	Additional contract documents relevant to the Project that may be required by existing laws and/or the Procuring Entity, such as construction schedule and S-curve, manpower schedule, construction methods, equipment utilization schedule, construction safety and health program approved by the DOLE, and other acceptable tools of project scheduling.												

## ***Section IV. General Conditions of Contract***

## 1. **Scope of Contract**

This Contract shall include all such items, although not specifically mentioned, that can be reasonably inferred as being required for its completion as if such items were expressly mentioned herein. All the provisions of RA No. 9184 and its 2016 revised IRR, including the Generic Procurement Manual, and associated issuances, constitute the primary source for the terms and conditions of the Contract, and thus, applicable in contract implementation. Herein clauses shall serve as the secondary source for the terms and conditions of the Contract.

This is without prejudice to Sections 74.1 and 74.2 of the 2016 revised IRR of RA No. 9184 allowing the GPPB to amend the IRR, which shall be applied to all procurement activities, the advertisement, posting, or invitation of which were issued after the effectivity of the said amendment.

## 2. **Sectional Completion of Works**

If sectional completion is specified in the **Special Conditions of Contract (SCC)**, references in the Conditions of Contract to the Works, the Completion Date, and the Intended Completion Date shall apply to any Section of the Works (other than references to the Completion Date and Intended Completion Date for the whole of the Works).

## 3. **Possession of Site**

3.1 The Procuring Entity shall give possession of all or parts of the Site to the Contractor based on the schedule of delivery indicated in the **SCC**, which corresponds to the execution of the Works. If the Contractor suffers delay or incurs cost from failure on the part of the Procuring Entity to give possession in accordance with the terms of this clause, the Procuring Entity's Representative shall give the Contractor a Contract Time Extension and certify such sum as fair to cover the cost incurred, which sum shall be paid by Procuring Entity.

3.2 If possession of a portion is not given by the above date, the Procuring Entity will be deemed to have delayed the start of the relevant activities. The resulting adjustments in contract time to address such delay may be addressed through contract extension provided under Annex "E" of the 2016 revised IRR of RA No. 9184.

## 4. **The Contractor's Obligations**

The Contractor shall employ the key personnel named in the Schedule of Key Personnel indicating their designation, in accordance with **ITB** Clause 10.3 and specified in the **BDS**, to carry out the supervision of the Works.

The Procuring Entity will approve any proposed replacement of key personnel only if their relevant qualifications and abilities are equal to or better than those of the personnel listed in the Schedule.

## **5. Performance Security**

- 5.1. Within ten (10) calendar days from receipt of the Notice of Award from the Procuring Entity but in no case later than the signing of the contract by both parties, the successful Bidder shall furnish the performance security in any of the forms prescribed in Section 39 of the 2016 revised IRR.
- 5.2. The Contractor, by entering into the Contract with the Procuring Entity, acknowledges the right of the Procuring Entity to institute action pursuant to RA No. 3688 against any subcontractor be they an individual, firm, partnership, corporation, or association supplying the Contractor with labor, materials and/or equipment for the performance of this Contract.

## **6. Site Investigation Reports**

The Contractor, in preparing the Bid, shall rely on any Site Investigation Reports referred to in the SCC supplemented by any information obtained by the Contractor.

## **7. Warranty**

- 7.1. In case the Contractor fails to undertake the repair works under Section 62.2.2 of the 2016 revised IRR, the Procuring Entity shall forfeit its performance security, subject its property(ies) to attachment or garnishment proceedings, and perpetually disqualify it from participating in any public bidding. All payables of the GOP in his favor shall be offset to recover the costs.
- 7.2. The warranty against Structural Defects/Failures, except that occasioned-on force majeure, shall cover the period from the date of issuance of the Certificate of Final Acceptance by the Procuring Entity. Specific duration of the warranty is found in the SCC.

## **8. Liability of the Contractor**

Subject to additional provisions, if any, set forth in the SCC, the Contractor's liability under this Contract shall be as provided by the laws of the Republic of the Philippines.

If the Contractor is a joint venture, all partners to the joint venture shall be jointly and severally liable to the Procuring Entity.

## **9. Termination for Other Causes**

Contract termination shall be initiated in case it is determined *prima facie* by the Procuring Entity that the Contractor has engaged, before, or during the implementation of the contract, in unlawful deeds and behaviors relative to contract acquisition and implementation, such as, but not limited to corrupt, fraudulent, collusive, coercive, and obstructive practices as stated in ITB Clause 4.

## **10. Dayworks**

Subject to the guidelines on Variation Order in Annex “E” of the 2016 revised IRR of RA No. 9184, and if applicable as indicated in the SCC, the Dayworks rates in the Contractor’s Bid shall be used for small additional amounts of work only when the Procuring Entity’s Representative has given written instructions in advance for additional work to be paid for in that way.

## **11. Program of Work**

11.1. The Contractor shall submit to the Procuring Entity’s Representative for approval the said Program of Work showing the general methods, arrangements, order, and timing for all the activities in the Works. The submissions of the Program of Work are indicated in the SCC.

11.2. The Contractor shall submit to the Procuring Entity’s Representative for approval an updated Program of Work at intervals no longer than the period stated in the SCC. If the Contractor does not submit an updated Program of Work within this period, the Procuring Entity’s Representative may withhold the amount stated in the SCC from the next payment certificate and continue to withhold this amount until the next payment after the date on which the overdue Program of Work has been submitted.

## **12. Instructions, Inspections and Audits**

The Contractor shall permit the GOP or the Procuring Entity to inspect the Contractor’s accounts and records relating to the performance of the Contractor and to have them audited by auditors of the GOP or the Procuring Entity, as may be required.

## **13. Advance Payment**

The Procuring Entity shall, upon a written request of the Contractor which shall be submitted as a Contract document, make an advance payment to the Contractor in an amount not exceeding fifteen percent (15%) of the total contract price, to be made in lump sum, or at the most two installments according to a schedule specified in the SCC, subject to the requirements in Annex “E” of the 2016 revised IRR of RA No. 9184.

## **14. Progress Payments**

The Contractor may submit a request for payment for Work accomplished. Such requests for payment shall be verified and certified by the Procuring Entity’s Representative/Project Engineer. Except as otherwise stipulated in the SCC, materials and equipment delivered on the site but not completely put in place shall not be included for payment.

## **15. Operating and Maintenance Manuals**

- 15.1. If required, the Contractor will provide “as built” Drawings and/or operating and maintenance manuals as specified in the **SCC**.
- 15.2. If the Contractor does not provide the Drawings and/or manuals by the dates stated above, or they do not receive the Procuring Entity’s Representative’s approval, the Procuring Entity’s Representative may withhold the amount stated in the **SCC** from payments due to the Contractor.



## ***Section V. Special Conditions of Contract***

# Special Conditions of Contract

GCC Clause	
2	N/A
4.1	Schedule of construction in full shall start within <b>7 calendar days</b> from receipt of the Notice to Proceed
6	N/A
7.2	[In case of semi-permanent structures, such as buildings of types 1, 2, and 3 as classified under the National Building Code of the Philippines, concrete/asphalt roads, concrete river control, drainage, irrigation lined canals, river landing, deep wells, rock causeway, pedestrian overpass, and other similar semi-permanent structures:] Five (5) years.
10	a. Dayworks are applicable at the rate shown in the Contractor's original Bid.
11.1	The Contractor shall submit the Program of Work (PERT-CPM, Construction Schedule, S-Curve and Construction Methods) to the Procuring Entity's Representative within 10 calendar days of delivery of the Notice of Award.
11.2	The amount to be withheld for late submission of an updated Program of Work is 10% of the 15% Advance Payment.
13	The amount of the advance payment is 15% of the Contract Price.
14	Materials and equipment delivered on the site but not completely put in place (Actual Accomplishment) shall <b>not</b> be included for payment.
15.1	The "as built" Drawings and/or operating and maintenance manuals shall be required prior to the final payment.
15.2	The amount to be withheld for failing to produce "as built" drawings and/or operating and maintenance manuals by the date required is 10% of the final billing.

## *Section VI. Specifications*

## ***Section VII. Drawings***

*[Insert here a list of Drawings. The actual Drawings, including site plans, should be attached to this section, or annexed in a separate folder.]*

## *Section VIII. Bill of Quantities*

***Section IX. Checklist of Technical and Financial Documents***

# Checklist of Technical and Financial Documents

## I. TECHNICAL COMPONENT ENVELOPE

### *Class “A” Documents*

#### Legal Documents

- (a) Valid PhilGEPS Registration Certificate (Platinum Membership) (all pages) in accordance with Section 8.5.2 of the IRR;

#### Technical Documents

- (b) Statement of the prospective bidder of all its ongoing government and private contracts, including contracts awarded but not yet started, if any, whether similar or not similar in nature and complexity to the contract to be bid; **and**
- (c) Statement of the bidder’s Single Largest Completed Contract (SLCC) similar to the contract to be bid, except under conditions provided under the rules; **and**
- (d) Special PCAB License in case of Joint Ventures; **and** registration for the type and cost of the contract to be bid; **and**
- (e) Original copy of Bid Security. If in the form of a Surety Bond, submit also a certification issued by the Insurance Commission; **or**  
Original copy of Notarized Bid Securing Declaration; **and**
- (f) Project Requirements, which shall include the following:
  - a. Organizational chart for the contract to be bid;
  - b. List of contractor’s key personnel (*e.g.*, Project Manager, Project Engineers, Materials Engineers, and Foremen), to be assigned to the contract to be bid, with their complete qualification and experience data;
  - c. List of contractor’s major equipment units, which are owned, leased, and/or under purchase agreements, supported by proof of ownership or certification of availability of equipment from the equipment lessor/vendor for the duration of the project, as the case may be; **and**
- (g) Original duly signed Omnibus Sworn Statement (OSS); **and** if applicable, Original Notarized Secretary’s Certificate in case of a corporation, partnership, or cooperative; or Original Special Power of Attorney of all members of the joint venture giving full power and authority to its officer to sign the OSS and do acts to represent the Bidder.

#### Financial Documents

- (h) The prospective bidder’s computation of Net Financial Contracting Capacity (NFCC).

### *Class “B” Documents*

- (i) If applicable, duly signed joint venture agreement (JVA) in accordance with RA No. 4566 and its IRR in case the joint venture is already in existence; **or**  
duly notarized statements from all the potential joint venture partners stating

that they will enter into and abide by the provisions of the JVA in the instance that the bid is successful.

## II. FINANCIAL COMPONENT ENVELOPE

- (j) Original of duly signed and accomplished Financial Bid Form; **and**

### Other documentary requirements under RA No. 9184

- (k) Original of duly signed Bid Prices in the Bill of Quantities; **and**
- (l) Duly accomplished Detailed Estimates Form, including a summary sheet indicating the unit prices of construction materials, labor rates, and equipment rentals used in coming up with the Bid; **and**
- (m) Cash Flow by Quarter.







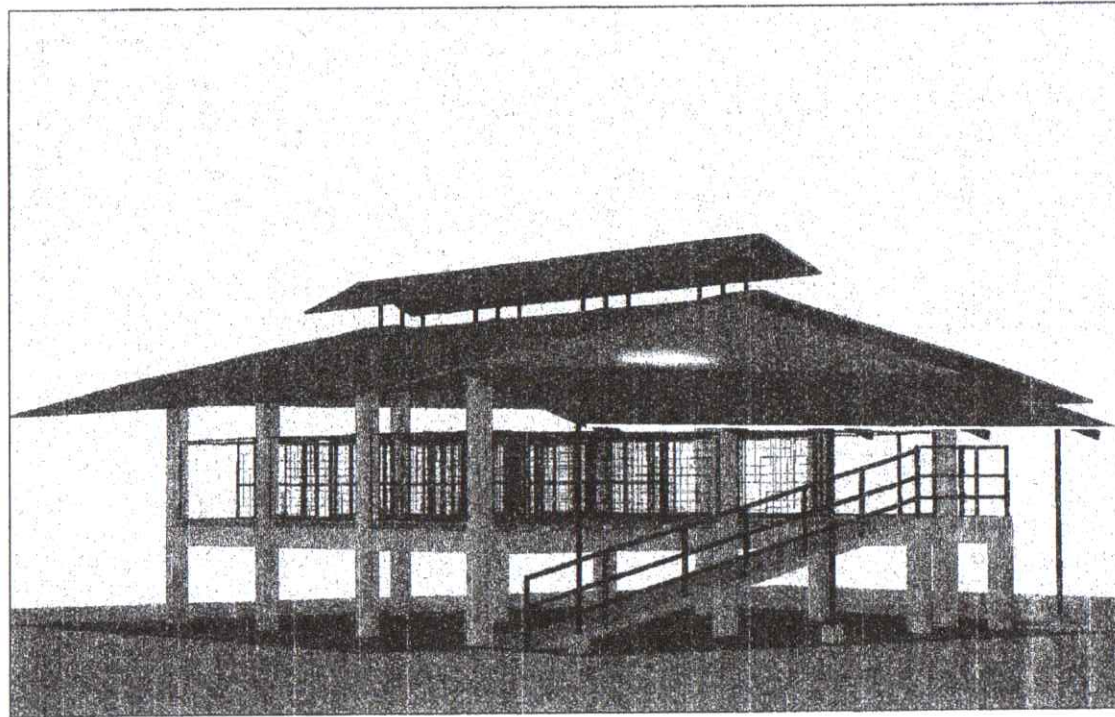

**PERSPECTIVE VIEW**  
SCALE: NTS

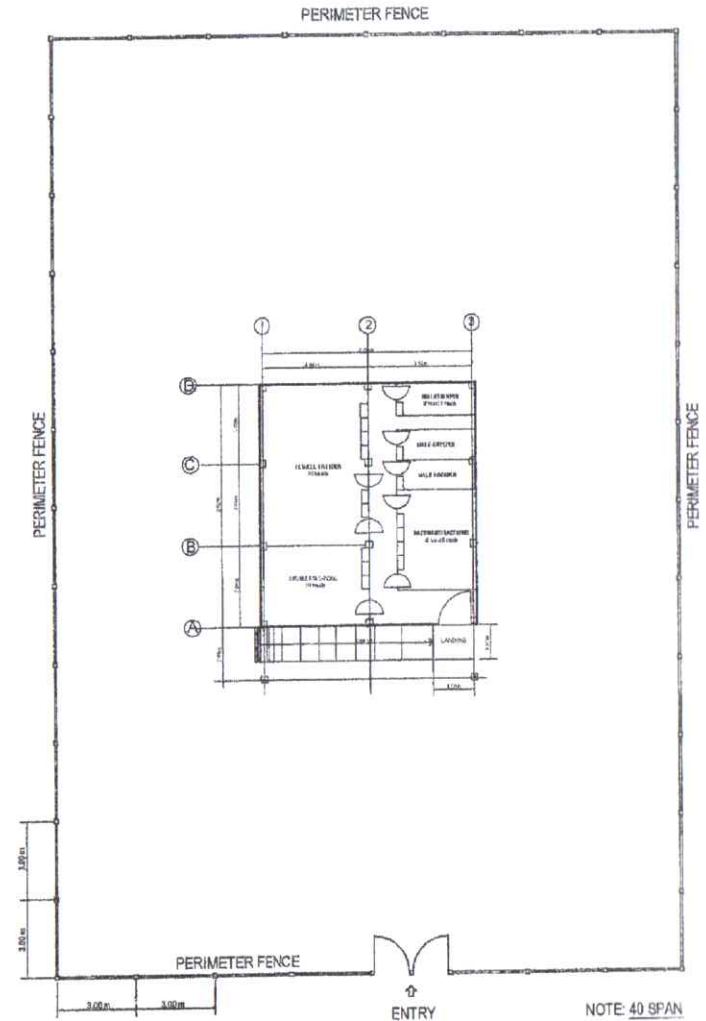

**PERIMETER FENCE PLAN**  
SCALE: 1:200mts

PREPARED FROM THE OFFICE OF THE:	PROJECT TITLE:	PREPARED BY:	CHECKED & REVIEWED BY:	RECOMMENDING APPROVAL:	APPROVED:	SHEET CONTENTS	SHEET NO.
<p>STATE OF LOUISIANA <b>DEPARTMENT OF AGRICULTURE</b> REGIONAL FIELD OFFICE NO. 1 400 LA 1014 BELLVILLE, LA 70448 <b>REGIONAL AGRICULTURAL ENGINEERING DIVISION</b></p>	<p><b>CONSTRUCTION OF GOAT BREEDER HOUSE</b></p> <p>LOCATION: REGION 1</p>	<p>SARAH JANE T. CAYME, ABE <i>SJC</i></p>	<p>MARK HARRY G. PASTOR, ABE <i>MHP</i></p>	<p>DEAN M. TACTAC, ABE <i>DMT</i></p>	<p>ANNIE Q. BARES, DVM <i>AQB</i></p>	<p>SITE DEVELOPMENT PLAN PERSPECTIVE VIEW</p>	<p>1 15</p>

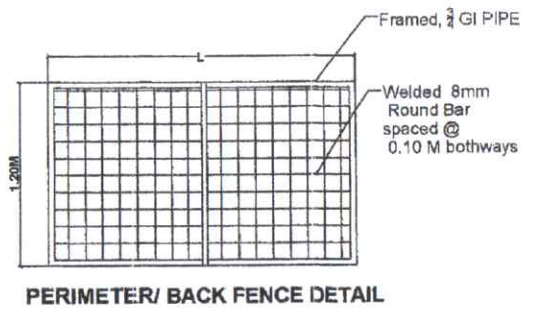
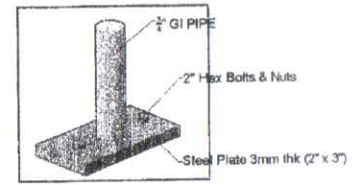
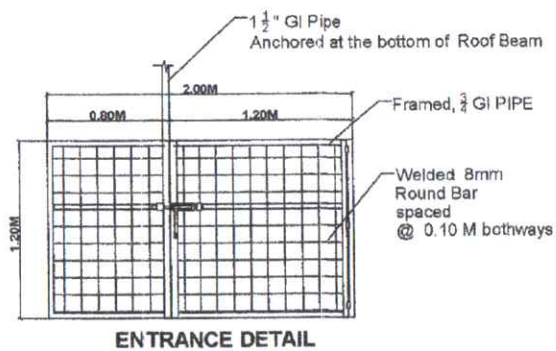
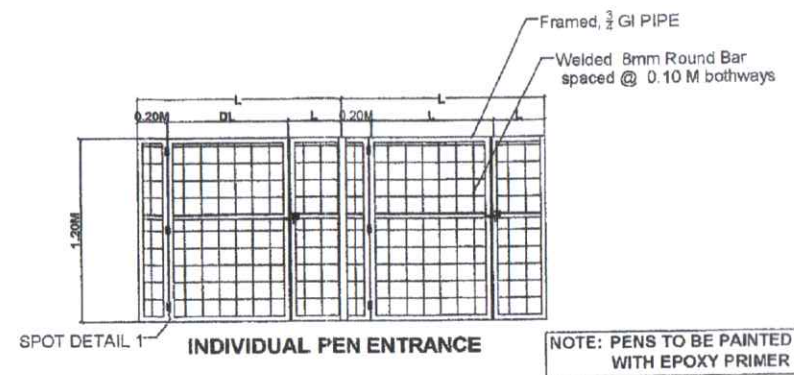
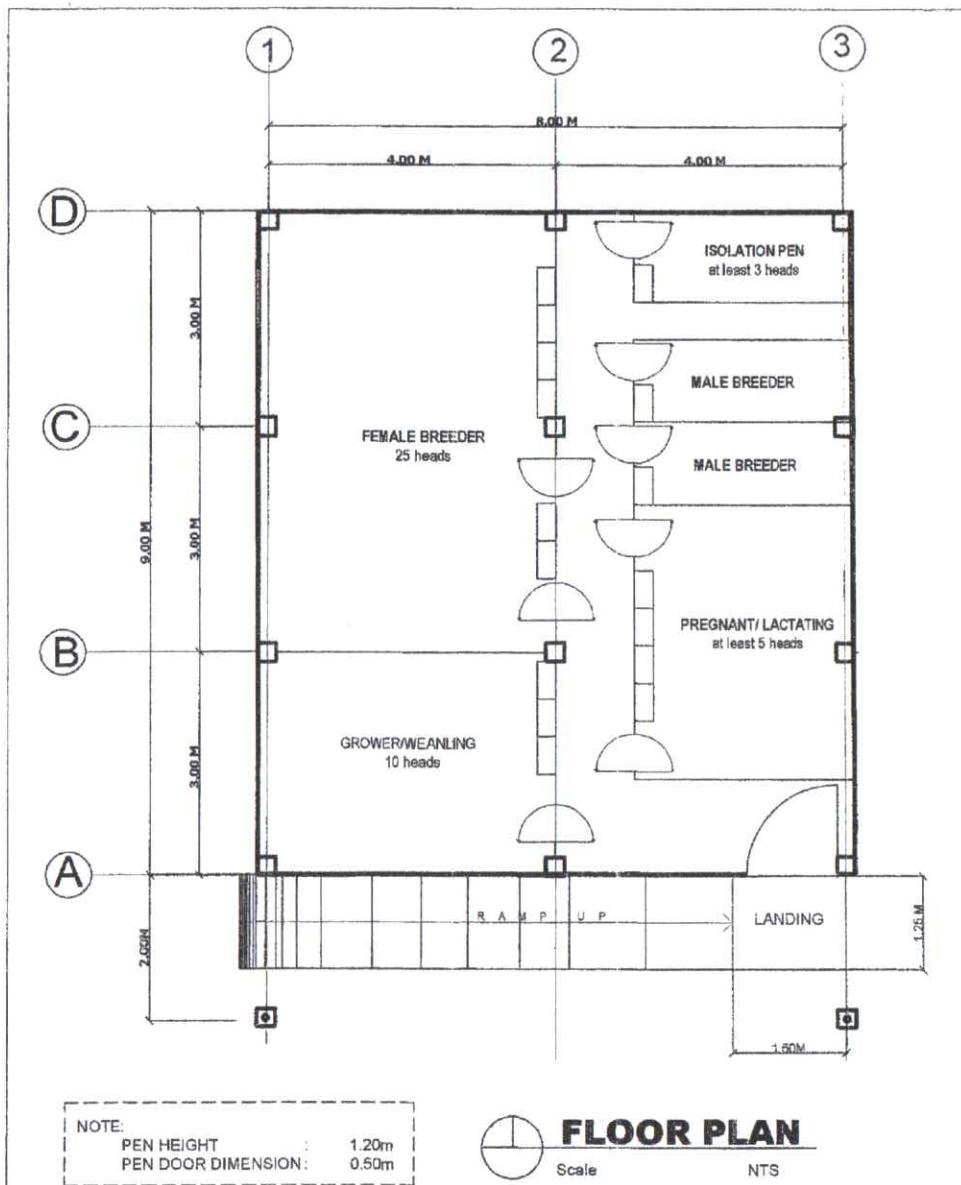

PREPARED FROM THE OFFICE OF THE <b>DEPARTMENT OF AGRICULTURE</b> REGIONAL FIELD OFFICE NO. 1 REGIONAL AGRICULTURAL ENGINEERING DIVISION	PROJECT TITLE <b>CONSTRUCTION OF GOAT BREEDER HOUSE</b>	PREPARED BY: SARAH JANE T. CAJME, ABE	CHECKED & REVIEWED BY: MARK HARRY S. PASTOR, ABE	RECOMMENDING APPROVAL: OLIVIS I. TACTAC, ABE	APPROVED: ANNIE Q. BARES, DVM	SHEET CONTENTS FLOOR PLAN PEN DETAILS
--	--	--	---	---	----------------------------------	---

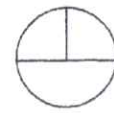
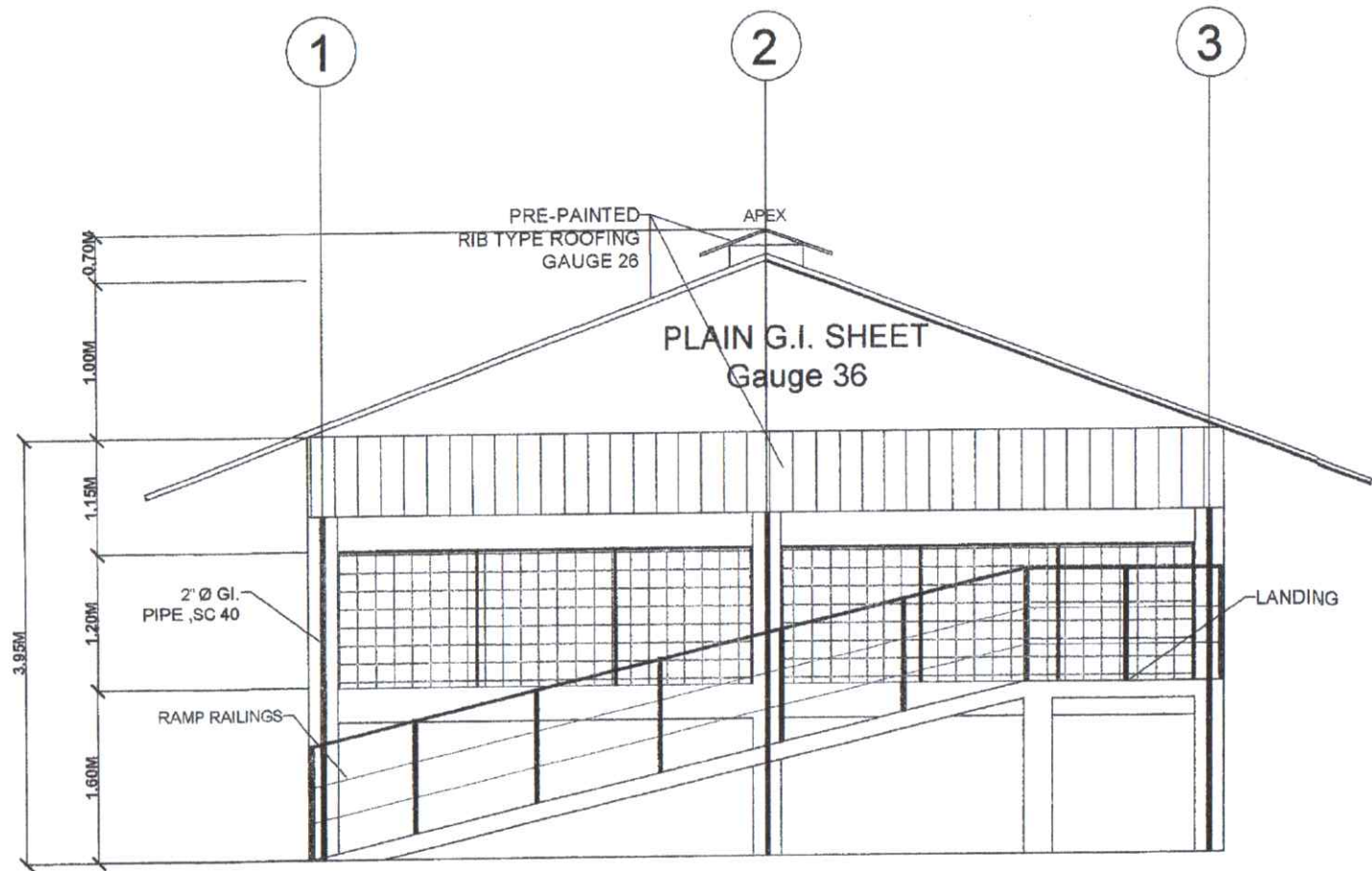

# FRONT VIEW ELEVATION

Scale NTS

PREPARED FROM THE OFFICE OF THE	PROJECT TITLE:	PREPARED BY:	CHECKED & REVIEWED BY:	RECOMMENDING APPROVAL	APPROVED	SHEET CONTENTS	SHEET
<small>OFFICE OF ENGINEERING</small> <b>DEPARTMENT OF AGRICULTURE</b> <small>REGIONAL FIELD OFFICE NO. 1</small> <small>AGRI. FIELD BLDG. 1, 2nd FLOOR, DAVAO CITY</small> <b>REGIONAL AGRICULTURAL ENGINEERING DIVISION</b>	<b>CONSTRUCTION OF GOAT BREEDER HOUSE</b>	 <b>SARAH JANE F. SAYME, ABE</b> <small>Regional Engineer</small>	 <b>MARK HARRY G. PASTOR, ABE</b> <small>Regional Engineer</small>	 <b>DENNIS TACTAL, ABE</b> <small>Regional Engineer</small>	 <b>ANNIE Q. BARES, DVM</b> <small>Regional Executive Director</small>	FRONT VIEW	1

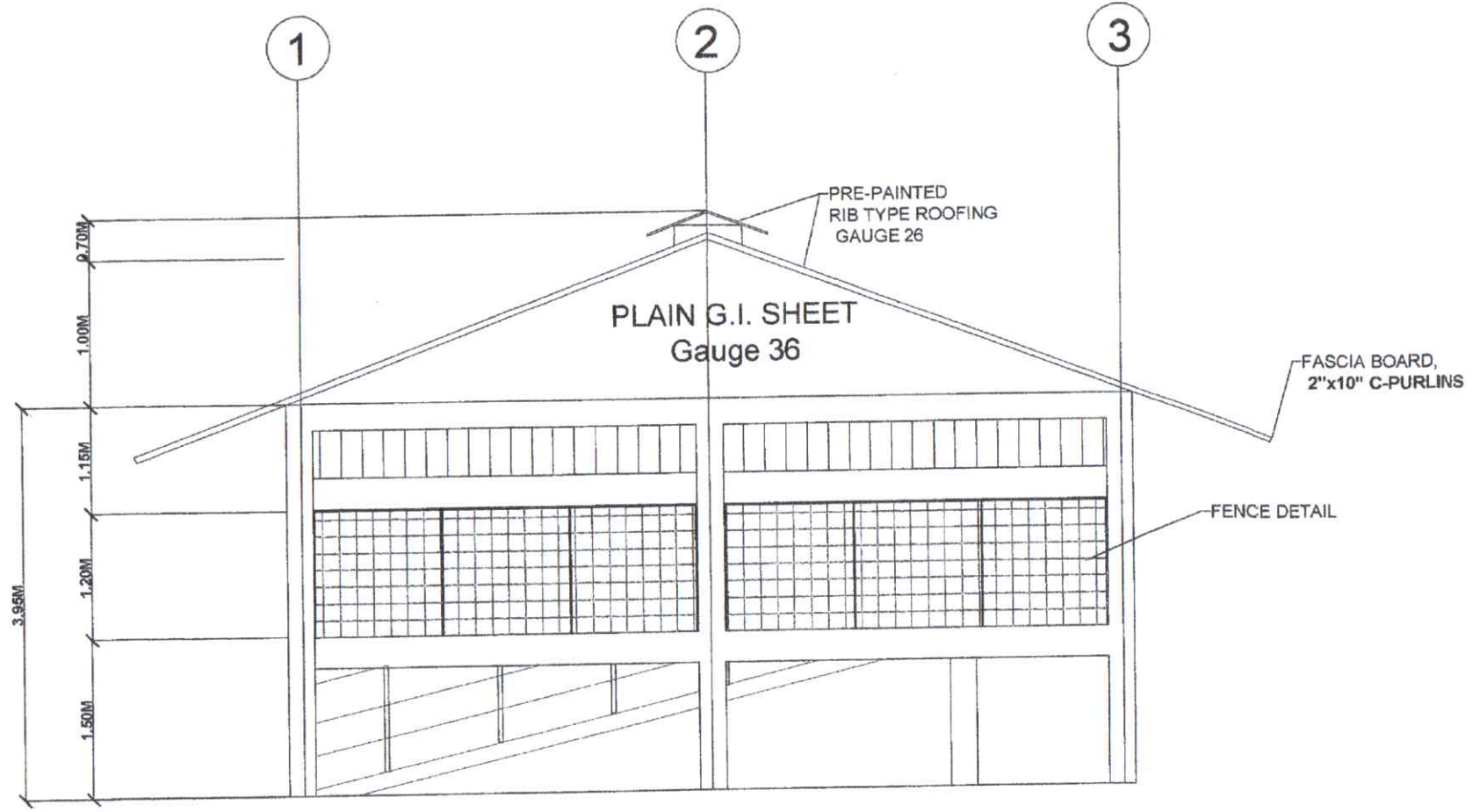

**REAR VIEW ELEVATION**  
 Scale NTS

PREPARED FROM THE OFFICE OF THE:	PROJECT TITLE:	PREPARED BY:	CHECKED & REVIEWED BY:	RECOMMENDING APPROVAL:	APPROVED:	SHEET CONTENTS:	SHEET:
REPUBLIC OF THE PHILIPPINES <b>DEPARTMENT OF AGRICULTURE</b> REGIONAL FIELD OFFICE NO. 1 REGIONAL AGRICULTURAL ENGINEERING DIVISION	<b>CONSTRUCTION OF GOAT BREEDER HOUSE</b> LOCATION: PG 020M 1	SARAH JANE Y. CAYME, ABE <i>(Signature)</i>	MARK HARRY G. PASTOR, ABE CHIEF, FAED <i>(Signature)</i>	DENNIS L. ... ABE ... <i>(Signature)</i>	ANNIE Q. BARES, DVM Regional Executive Director <i>(Signature)</i>	REAR VIEW	1

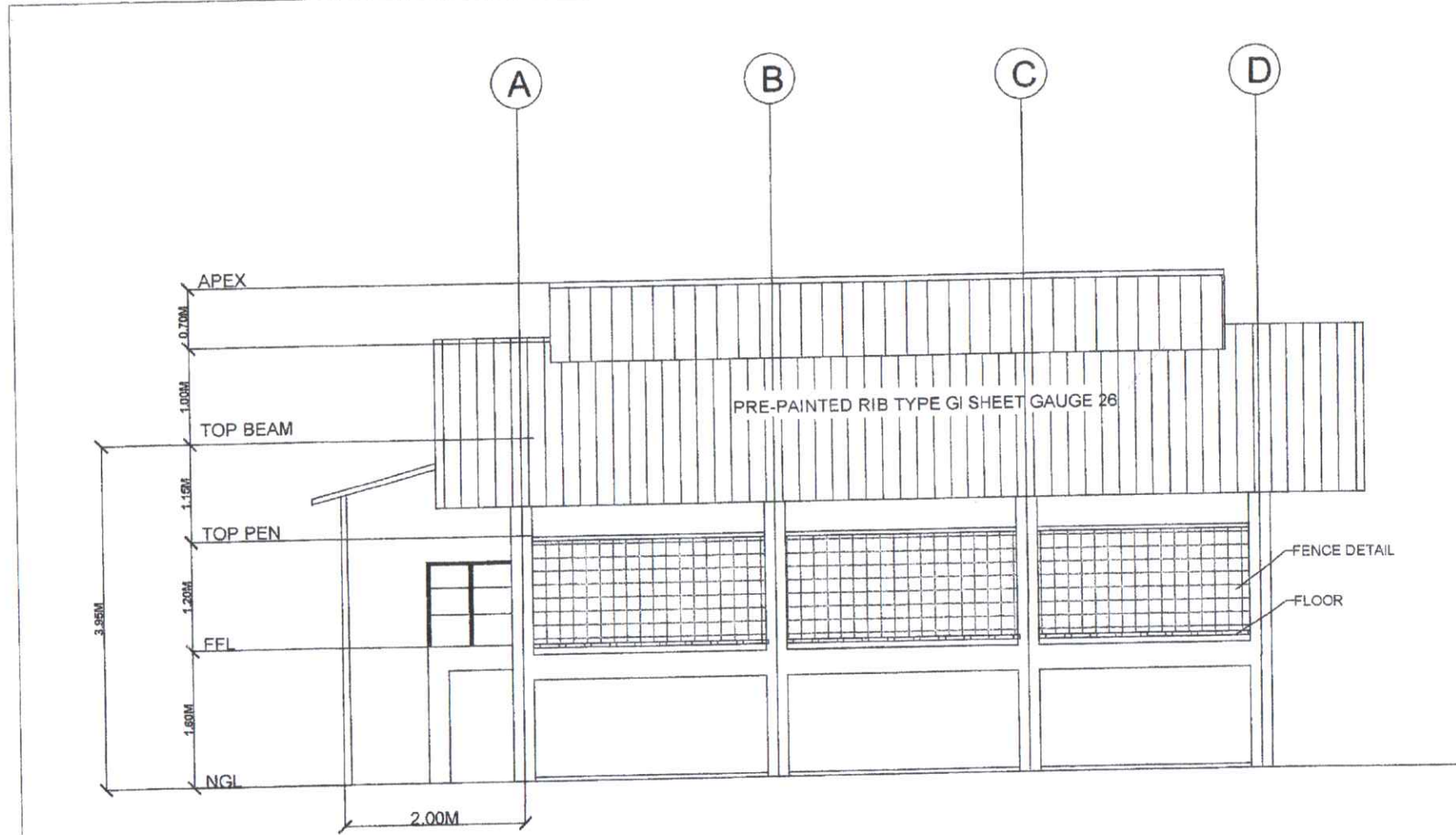

**RIGHT SIDE VIEW**  
 Scale NTS

PREPARED FROM THE OFFICE OF THE:	PROJECT TITLE:	PREPARED BY:	CHECKED & REVIEWED BY:	RECOMMENDING APPROVAL:	APPROVED:	SHEET CONTENTS	SHEET
REPUBLIC OF THE PHILIPPINES <b>DEPARTMENT OF AGRICULTURE</b> REGIONAL FIELD OFFICE NO. 1 POLARIS, BULACAN, BATAAN REGION <b>REGIONAL AGRICULTURAL ENGINEERING DIVISION</b>	<b>CONSTRUCTION OF GOAT BREEDER HOUSE</b> LOCATION: REGION 1	SARAH JAYE T. CAYME, ABE <i>(Signature)</i>	MARK HARRY B. PASTOR, ABE CHIEF, R.A.E.D. <i>(Signature)</i>	DENNIS L. SACTAC, ABE REGIONAL AGRICULTURAL ENGINEER <i>(Signature)</i>	ANNIE Q. BARES, DVM Regional Executive Director <i>(Signature)</i>	RIGHT SIDE VIEW	( )

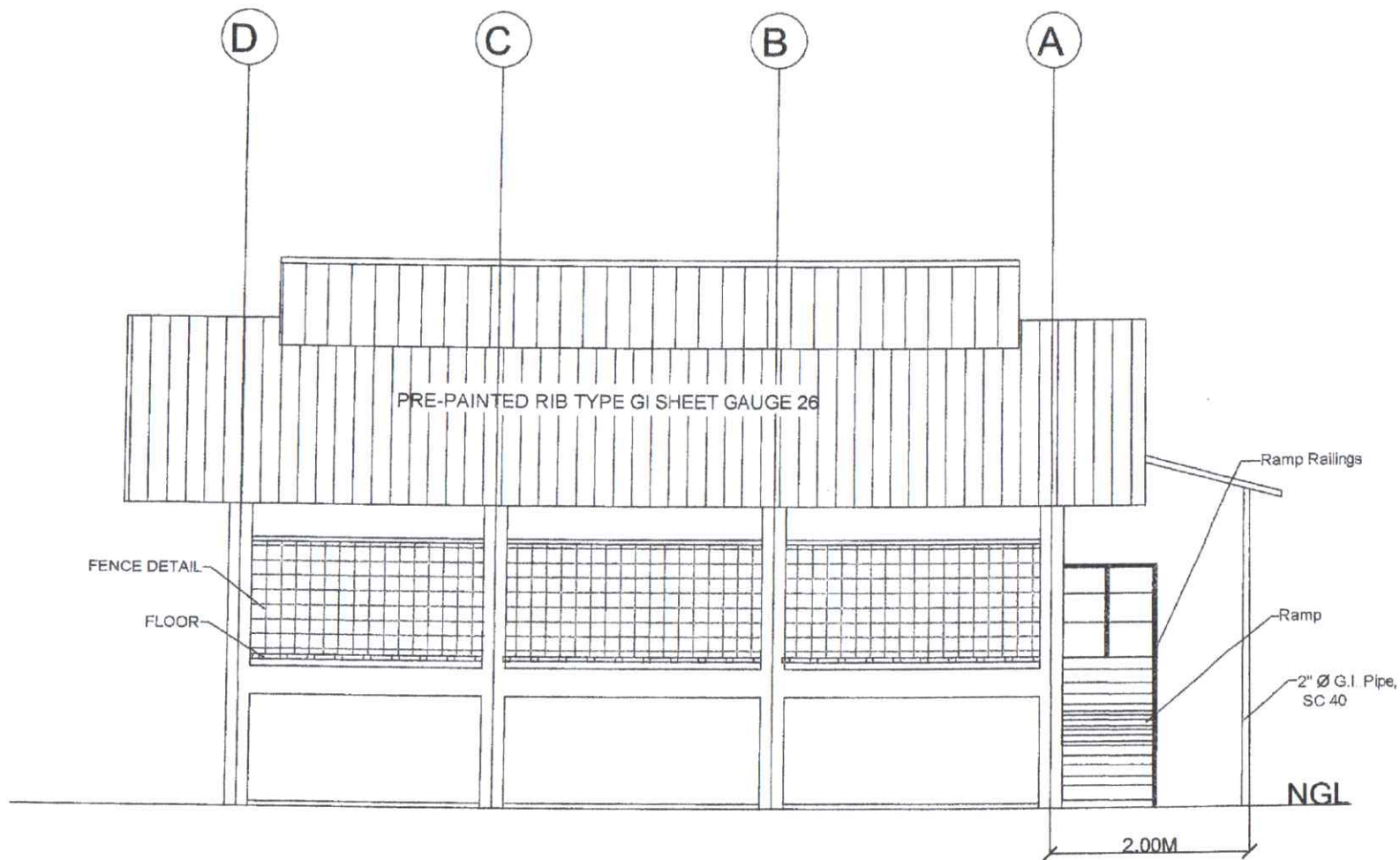

 **LEFT SIDE VIEW**  
Scale NTS

<p>PREPARED FROM THE OFFICE OF THE:</p> <p><b>REPUBLIC OF THE PHILIPPINES</b> <b>DEPARTMENT OF AGRICULTURE</b> REGIONAL FIELD OFFICE NO. 1 AGRICULTURAL BLDG. DEL MONTE CITY, BANGAL</p> <p><b>REGIONAL AGRICULTURAL ENGINEERING DIVISION</b></p>	<p>PROJECT TITLE:</p> <p><b>CONSTRUCTION OF GOAT BREEDER HOUSE</b></p> <p>LOCATION: #2020R1</p>	<p>PREPARED BY:</p> <p><i>S. J. C.</i> <b>SARAH JANE T. CAJME, ABE</b> Architect</p>	<p>CHECKED &amp; REVIEWED BY:</p> <p><i>M. H. P.</i> <b>MARK HARRY G. PASTOR, ABE</b> CIVIL ENGINEER</p>	<p>RECOMMENDING APPROVAL:</p> <p><i>D. T. A.</i> <b>DENNIS TACTA, ABE</b> CIVIL ENGINEER</p>	<p>APPROVED:</p> <p><i>A. Q. B.</i> <b>ANNIE Q. BARES, DVM</b> Regional Director/Engineer</p>	<p>SHEET CONTENTS</p> <p>LEFT SIDE VIEW</p>	<p>SHEET NO.</p> <p>6 15</p>
---	---	--	--	--	---	---	----------------------------------



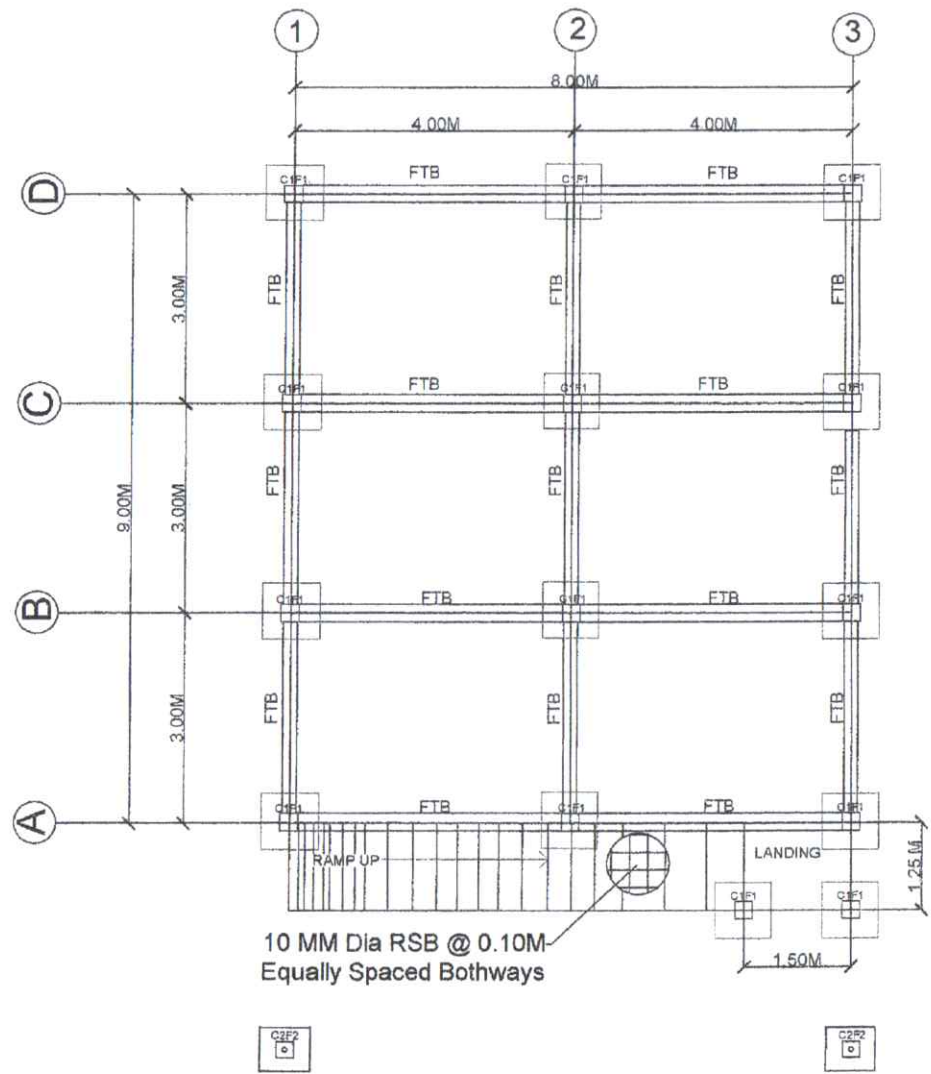

**FOUNDATION PLAN**  
Scale NTS

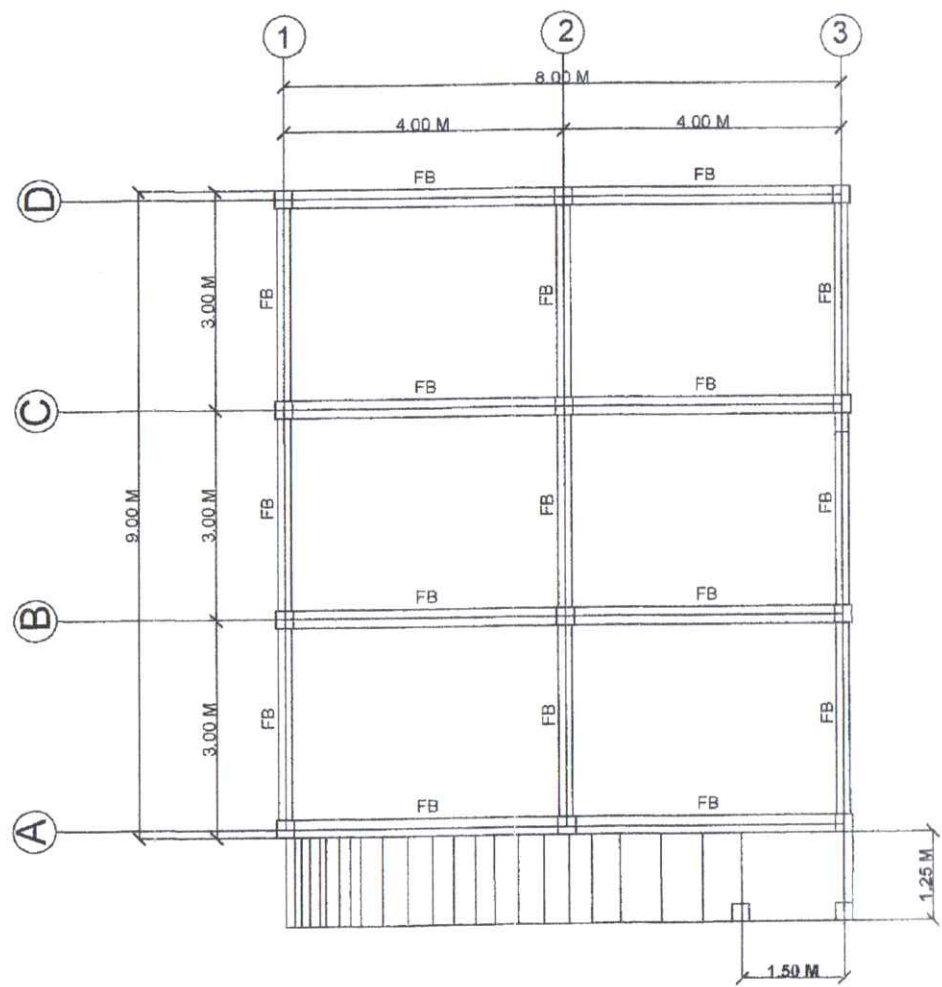

**FLOOR BEAM (FB) LAYOUT**  
Scale NTS

PREPARED FROM THE OFFICE OF THE:	PROJECT TITLE:	PREPARED BY:	CHECKED & REVIEWED BY:	RECOMMENDING APPROVAL:	APPROVED:	SHEET CONTENTS:	SHEET
	<b>CONSTRUCTION OF GOAT BREEDER HOUSE</b> LOCATION: MEGONGI	SARAH JANE T. CAYME, ABE <i>(Signature)</i>	MARK HARRY G. PASTOR, ABE <i>(Signature)</i>	DENNIS L. TACTAC, ABE <i>(Signature)</i>	ANNIE Q. BARES, DVM Regional Executive Director <i>(Signature)</i>	FOUNDATION PLAN FOOTING TIE BEAM	

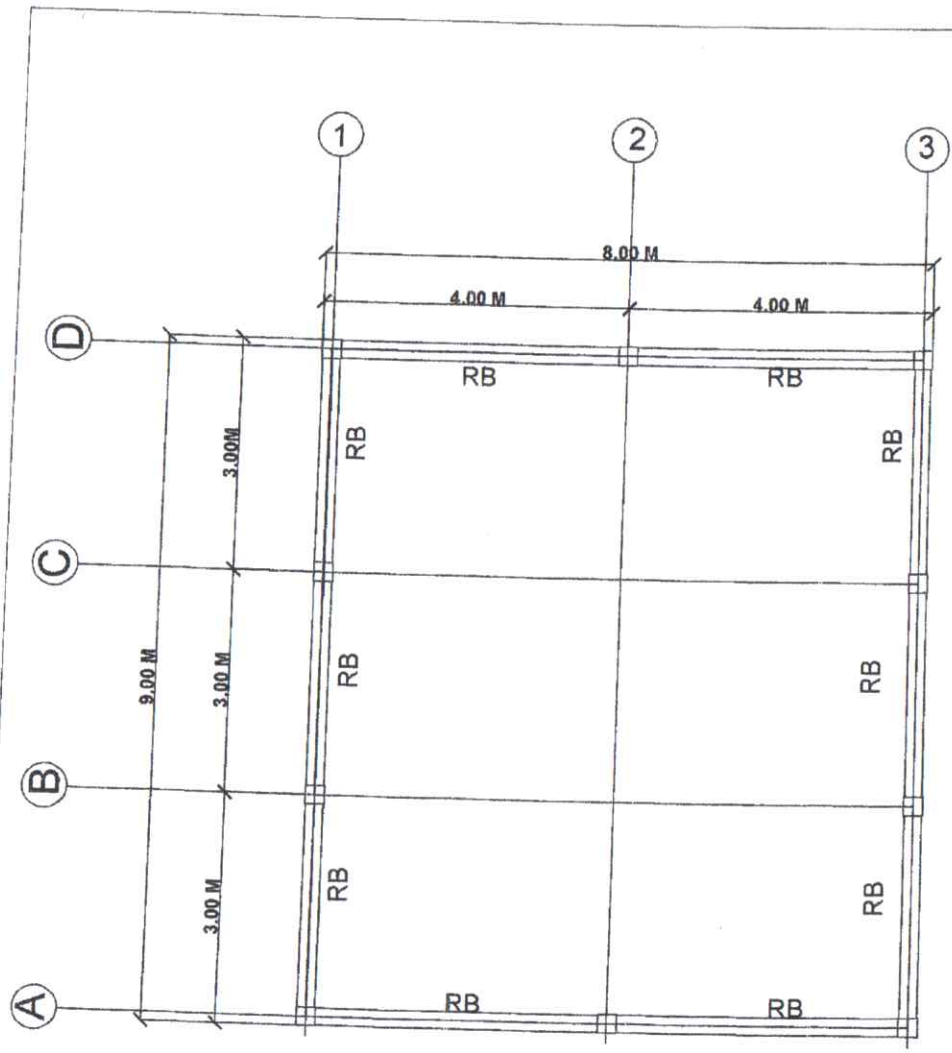

**ROOF BEAM PLAN**  
Scale NTS

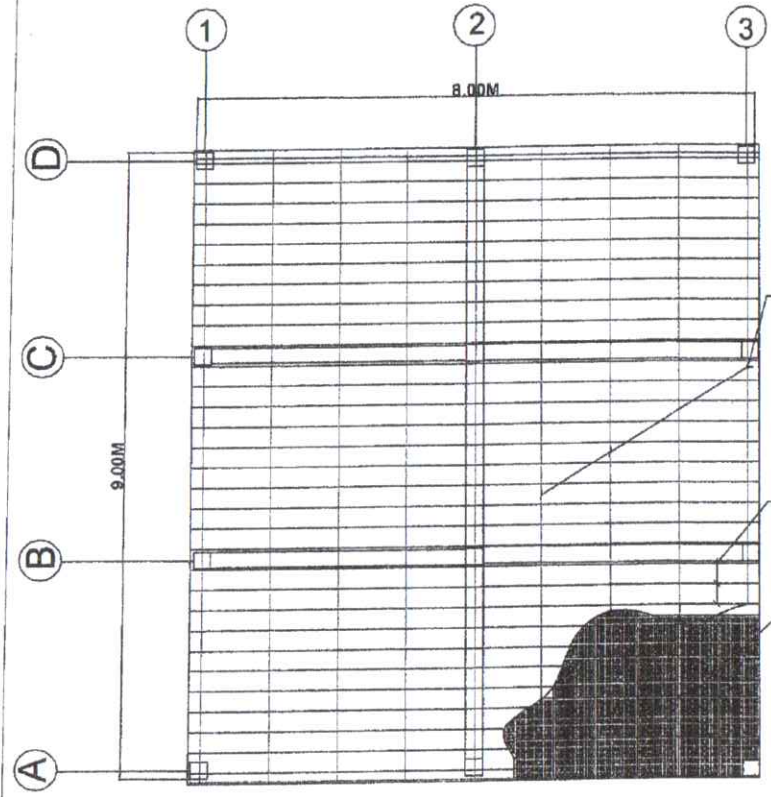

**FLOORING LAYOUT PLAN**  
Scale NTS

<p>PREPARED FROM THE OFFICE OF THE <b>DEPARTMENT OF AGRICULTURE</b> REGIONAL FIELD OFFICE NO. 1 REGIONAL AGRICULTURAL ENGINEERING DIVISION</p>	<p>PROJECT TITLE: <b>CONSTRUCTION OF GOAT BREEDER HOUSE</b></p>	<p>PREPARED BY: <i>SARAH JAYE T. CAYME, ABE</i></p>	<p>CHECKED &amp; REVIEWED BY: <i>MARK HARRY O. PASTOR, ABE</i></p>	<p>RECOMMENDING APPROVAL: <i>DENNIS I. TAGTAC, ABE</i></p>	<p>APPROVED: <i>ANNIE Q. BARES, DVM</i></p>	<p>SHEET CONTENTS: ROOF BEAM FLOORING LAYOUT PLAN</p>
--	---	---	--	--	---	---

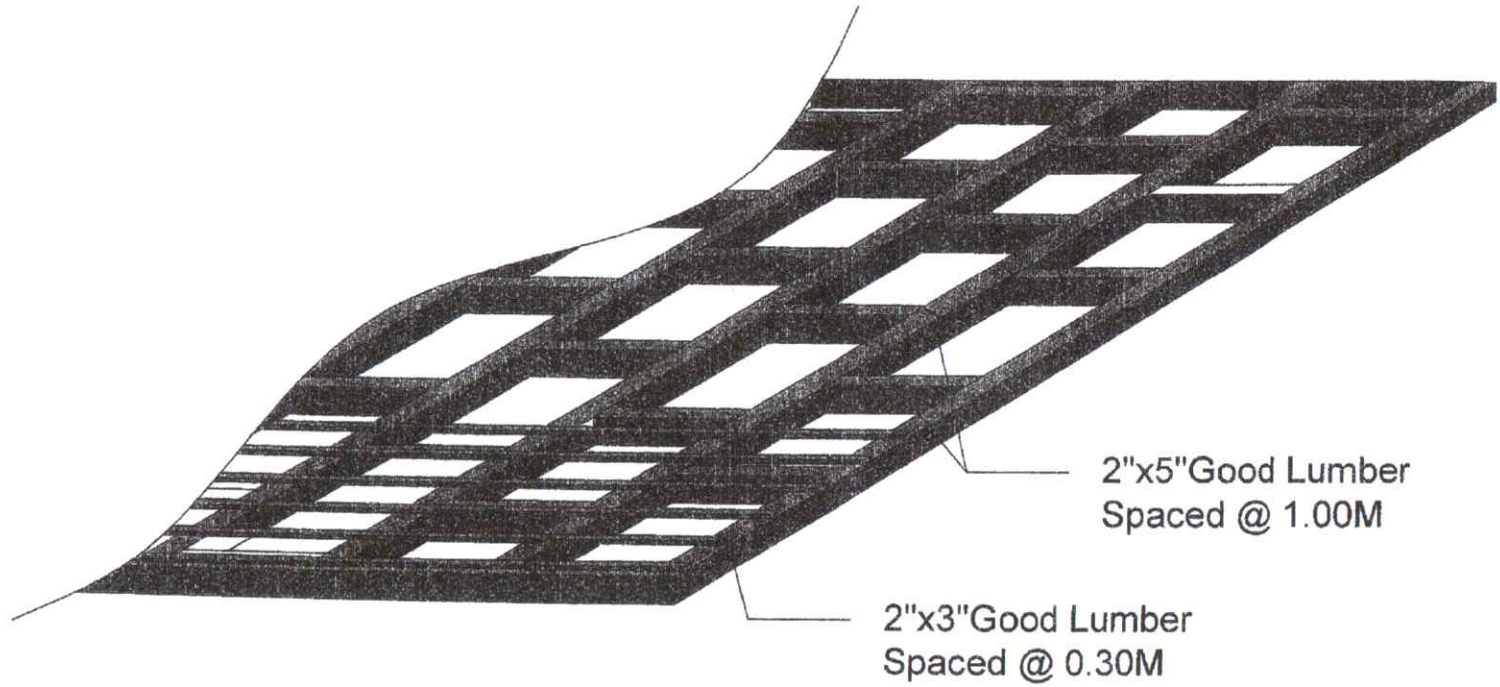

# FLOOR FRAMING LAYOUT

Scale

NTS

<p>PREPARED FROM THE OFFICE OF THE:</p> <p><b>DEPARTMENT OF AGRICULTURE</b> REGIONAL FIELD OFFICE NO. 1 MINDU ROAD, CUBILE, SAN FERRANDO CITY, TACUBA</p> <p><b>REGIONAL AGRICULTURAL ENGINEERING DIVISION</b></p> <p>02 Rev. 00, Eff. Date: 10/05/2020</p>	<p>PROJECT TITLE:</p> <p><b>CONSTRUCTION OF GOAT BREEDER HOUSE</b></p> <p>LOCATOR: REGION 1</p>	<p>PREPARED BY:</p> <p>SARAH JANE T. CAYME, ABE</p>	<p>CHECKED &amp; REVIEWED BY:</p> <p>MARK HARRY G. PASTOR, ABE</p>	<p>RECOMMENDING APPROVAL:</p> <p>DENNIS L. TACTAC, ABE</p>	<p>APPROVED:</p> <p>ANNIE Q. BARES, DVM</p>	<p>SHEET CONTENTS:</p> <p>FLOORING LAYOUT</p>	<p>SHEET:</p> <p>9 1</p>
---	---	---	--	--	---	---	------------------------------

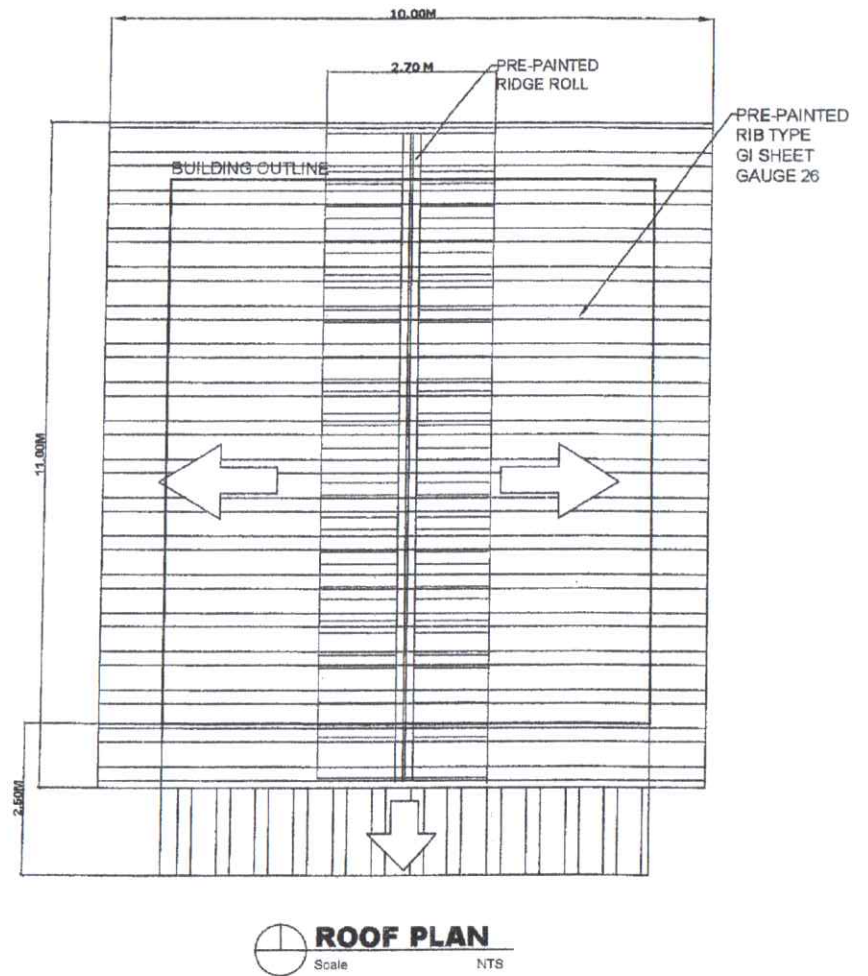
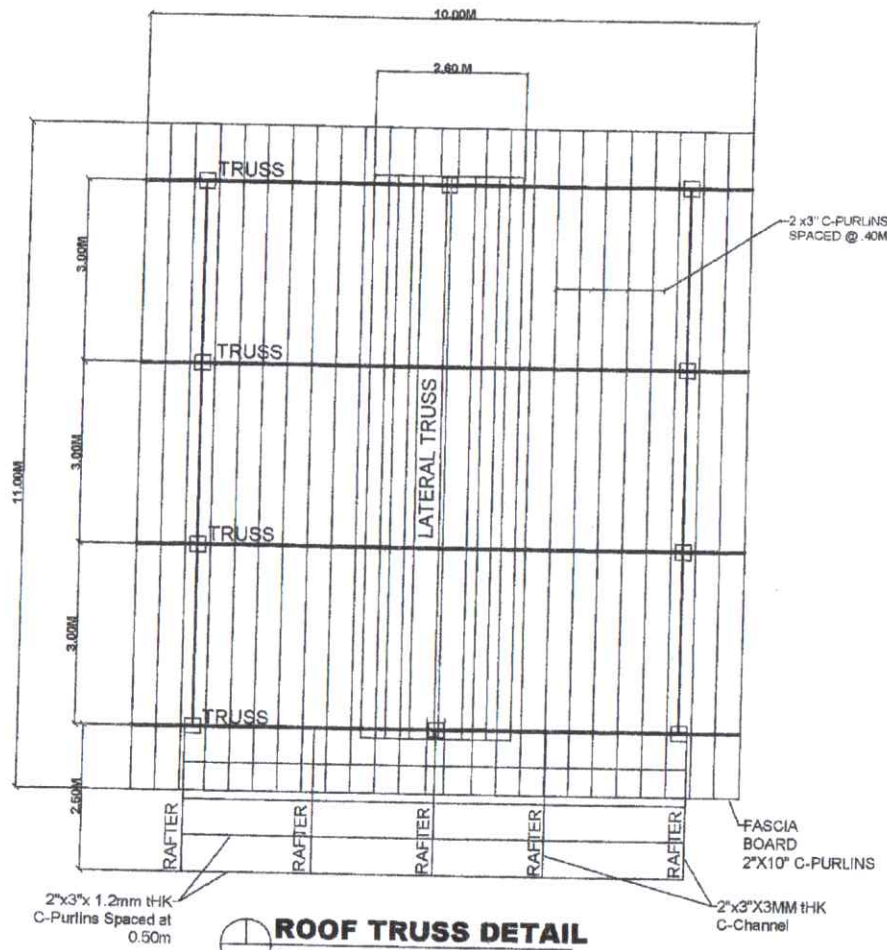

PREPARED FROM THE OFFICE OF THE: REPUBLIC OF THE PHILIPPINES <b>DEPARTMENT OF AGRICULTURE</b> REGIONAL FIELD OFFICE NO. 1 #Agricultural Extension Fair/Market Office, Iloilo <b>REGIONAL AGRICULTURAL ENGINEERING DIVISION</b>	PROJECT TITLE: <b>CONSTRUCTION OF GOAT BREEDER HOUSE</b>	PREPARED BY: SARAH JANE T. CAJOME, ABE <i>(Signature)</i>	CHECKED & REVIEWED BY: MARK HARRY G. PASTOR, ABE <i>(Signature)</i>	RECOMMENDING APPROVAL: DENNIS I. TAGAC, ABE <i>(Signature)</i>	APPROVED: ANNIE Q. BARES, DVM <i>(Signature)</i>	SHEET CONTENTS: ROOF TRUSS DETAIL ROOF PLAN	SHEET NO: 11 11
02 Rev. 00, Eff. Date: 10/05/2020	LOCATION: REGION 1	Technical Staff	Chief, RAED	ATO, RAED	Regional Director, RAED		

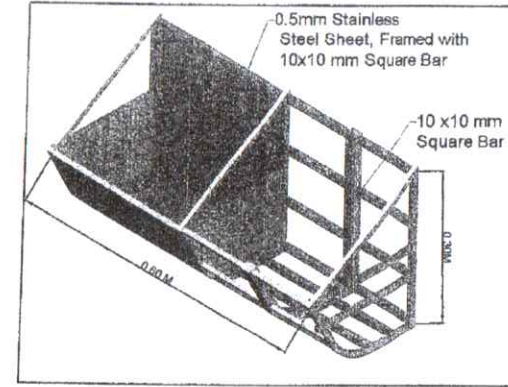
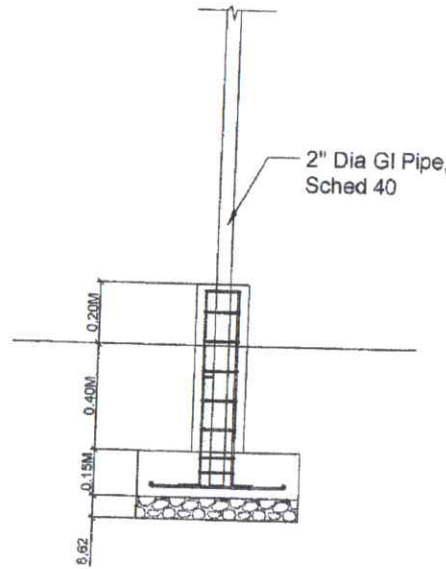
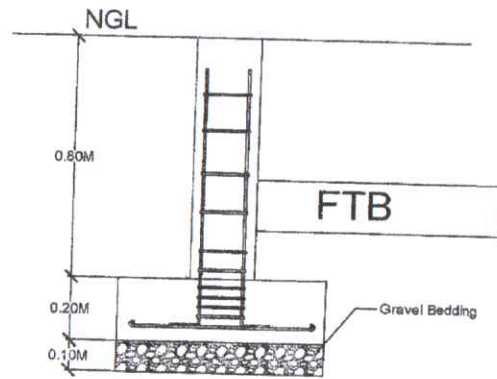

**FEEDING TROUGH**

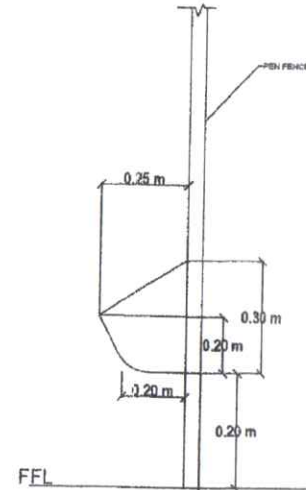

**SECTION**

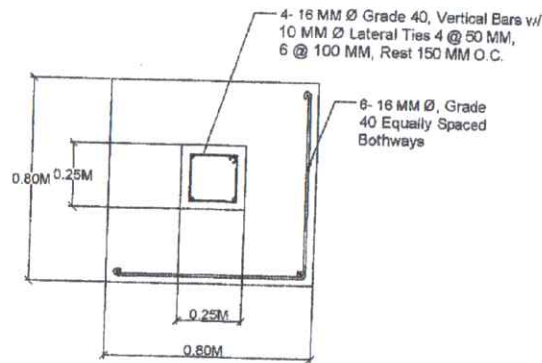

**C1F1 DETAIL**

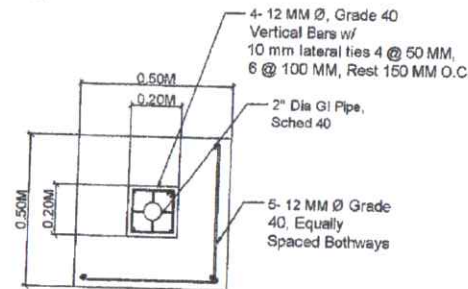

**C2F2 DETAIL**

DESCRIPTION	MEMBER	BEAM SCHEDULE				B	H	STIRRUPS
		SUPPORT		MIDSPAN				
		DETAILS	REBARS	DETAILS	REBARS			
FOOTING TIE BEAM	FTB		2-12 mm		2-12 mm	200	300	10 MM Ø SPACED AT 1-50 MM, 75-100MM, REST AT 150 MM
FLOOR BEAM	FB		2-18 mm		2-18 mm	250	300	10 MM Ø SPACED AT 1-50 MM, 75-100MM, REST AT 150 MM
ROOF BEAM	RB		2-16 mm		2-16 mm	200	300	10 MM Ø SPACED AT 1-50 MM, 75-100MM, REST AT 150 MM

PREPARED FROM THE OFFICE OF THE: <b>DEPARTMENT OF AGRICULTURE</b> REGIONAL FIELD OFFICE NO. 1 REGIONAL AGRICULTURAL ENGINEERING DIVISION	PROJECT TITLE: <b>CONSTRUCTION OF GOAT BREEDER HOUSE</b>	PREPARED BY: <i>Sarah Jane T. Cayme</i> <b>SARAH JANE T. CAYME, ABE</b>	CHECKED & REVIEWED BY: <i>Mark Harry G. Pastor</i> <b>MARK HARRY G. PASTOR, ABE</b>	RECOMMENDING APPROVAL: <i>Dennis I. Tagac</i> <b>DENNIS I. TAGAC, ABE</b>	APPROVED: <i>Annie Q. Bares</i> <b>ANNIE Q. BARES, DVM</b>	SHEET CONTENTS: AS SHOWN	SHEET NO: <b>11</b> <b>15</b>
---	---	---	---	---	--	-----------------------------	-------------------------------------

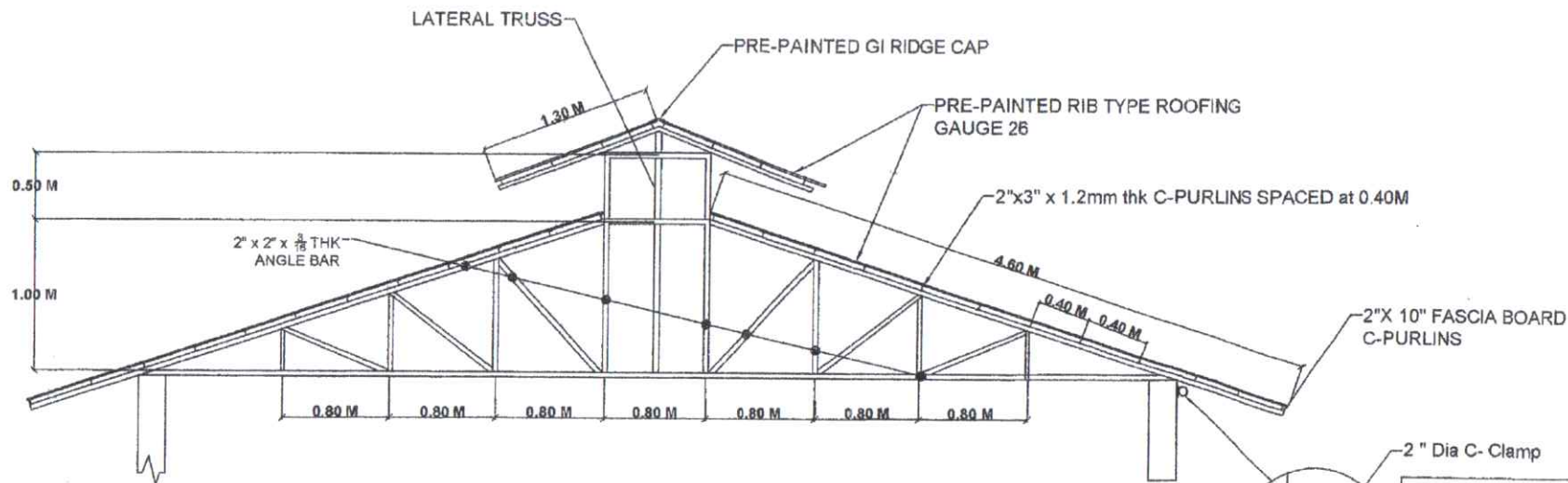

**TRUSS DETAIL**  
Scale NTS

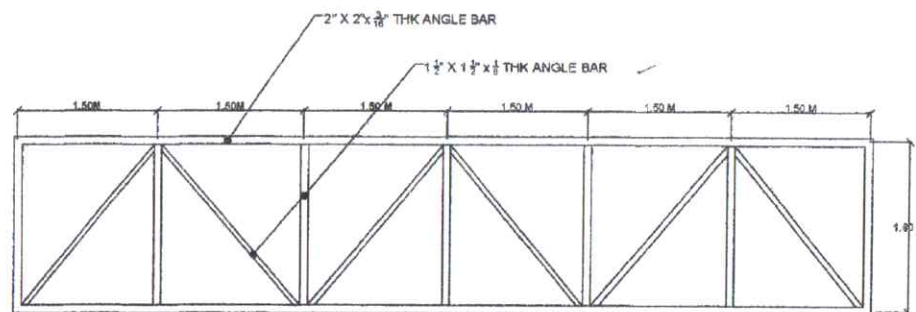
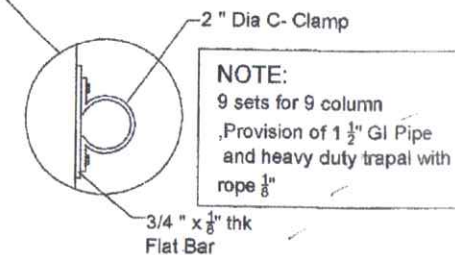

**LATERAL TRUSS DETAIL**  
Scale NTS

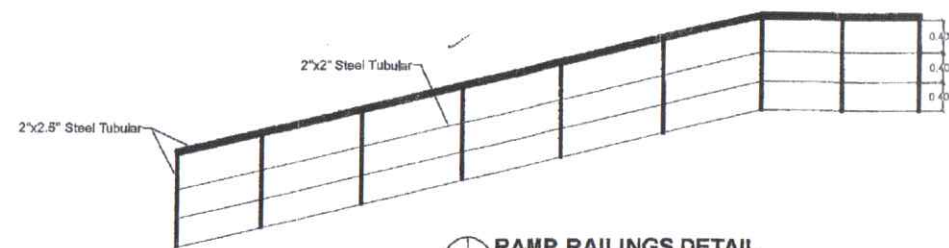

**RAMP RAILINGS DETAIL**  
Scale NTS

PREPARED FROM THE OFFICE OF THE:	PROJECT TITLE:	PREPARED BY:	CHECKED & REVIEWED BY:	RECOMMENDING APPROVAL:	APPROVED:	SHEET CONTENTS:	SHEET
<p>REPUBLIC OF THE PHILIPPINES <b>DEPARTMENT OF AGRICULTURE</b> REGIONAL FIELD OFFICE NO. 1 AGRI RISE AVENUE, BAYANG, CAGAYAN CITY <b>REGIONAL AGRICULTURAL ENGINEERING DIVISION</b></p>	<p><b>CONSTRUCTION OF GOAT BREEDER HOUSE</b></p> <p>LOCATION: BAMBOL</p>	<p>SARAH LANE T. CAYME, ABE <i>S.T.C.</i></p>	<p>MARK HARRY G. PASTOR, ABE <i>M.H.G.P.</i></p>	<p>DENNIS P. PACTAC, ABE <i>D.P.P.</i></p>	<p>ANNIE Q. BARES, DVM <i>A.Q.B.</i> Regional Executive Director</p>	AS SHOWN	

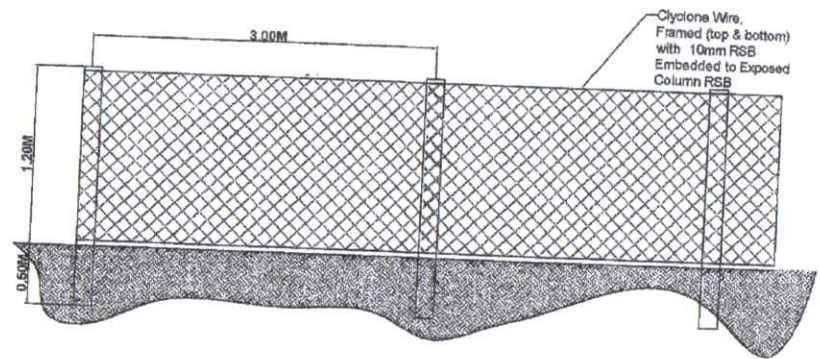

**PERIMETER FENCE PLAN**

Note: 40 Span

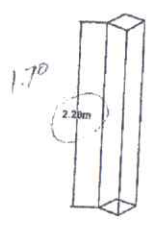

**COLUMN POST**

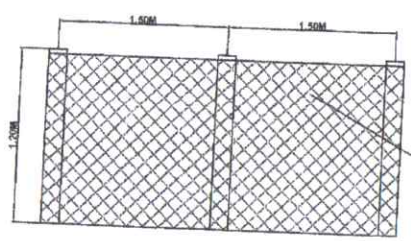

**ENTRANCE DETAIL**

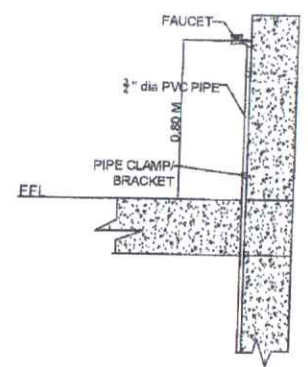
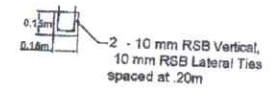

**SECTION**



**PLAN**

**OUTLET DETAIL**

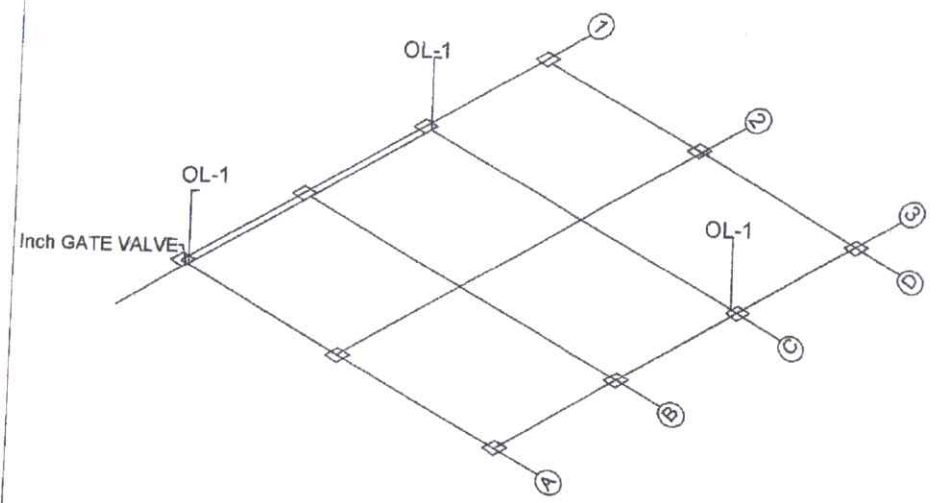

**ISOMETRIC LAYOUT OF PIPE**

PREPARED FROM THE OFFICE OF THE REPUBLIC OF THE PHILIPPINES <b>DEPARTMENT OF AGRICULTURE</b> REGIONAL FIELD OFFICE NO. 1 REGIONAL AGRICULTURAL ENGINEERING DIVISION	PROJECT TITLE: <b>CONSTRUCTION OF GOAT BREEDER HOUSE</b>	PREPARED BY: SARAH JANE T. CAYME, ABE <small>Technical Staff</small>	CHECKED & REVIEWED BY: MARK HARRY G. PASTOR, ABE <small>Chief Engr.</small>	RECOMMENDING APPROVAL: DENNIS T. TACTAC, ABE <small>Chief Engr.</small>	APPROVED: ANNIE Q. BARES, DVM <small>Regional Executive Director</small>	SHEET CONTENTS: PERIMETER FENCE PIPE LAYOUT	SHEET NO. 13 15
---	---	--	---	---	--	--	-----------------------

02 Rev. 00, Eff. Date: 10/05/2020

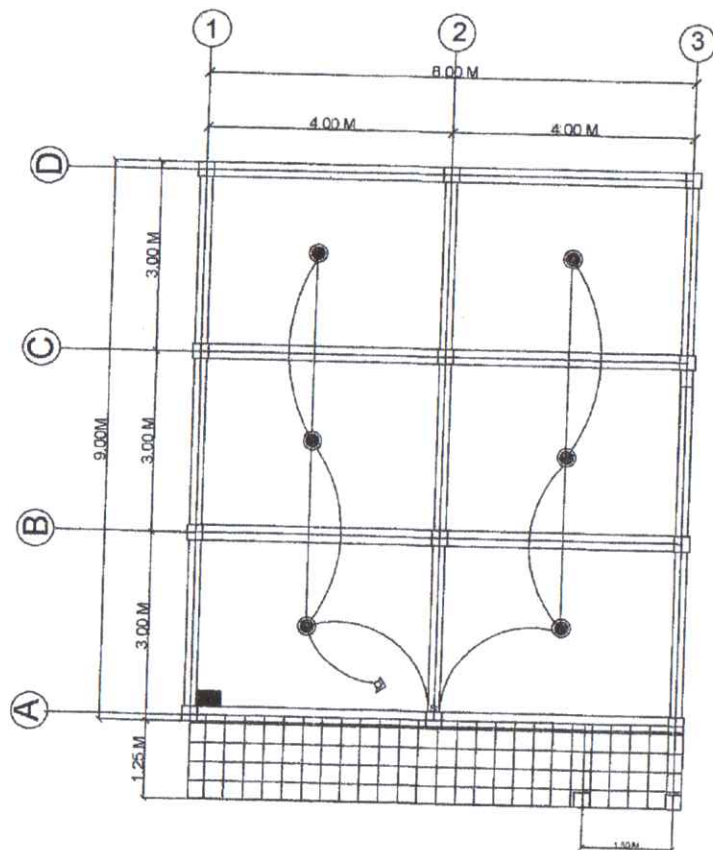

**SCHEDULE OF LOAD & COMPUTATION**

NO.	DESCRIPTION	QTY	WATTAGE	TOTAL VA	VOLTAGE	AMPERE	CIRCUIT BREAKER	SIZE OF WIRE	CONDUIT
1	WORKING OUTLET	6	100	600	220V	2.73	15AT	2.5 mm <sup>2</sup>	15mm x 2
2	SWITCH	1	1000	1000	220V	4.55	30AT	2.5 mm <sup>2</sup> BUND	20 mm x 2
<b>TOTAL</b>				<b>1,600 VA</b>		<b>6.28 AMP</b>			

DESIGN COMPUTATION:  
 TOTAL CONTINUOUS LOAD: 11.8 KW @ 40% DIVERSITY  
 FOR SERVICE EQUIPMENT: USE 15 AT @ 20 AMP, 2P MOLDED CASE CIRCUIT BREAKER, 230VAC @ 240V EXLT ON CB  
 FOR SERVICE CONDUCTOR: USE 2.5 mm<sup>2</sup> COPPER WIRE IN 20mm DIA RSC PIPE

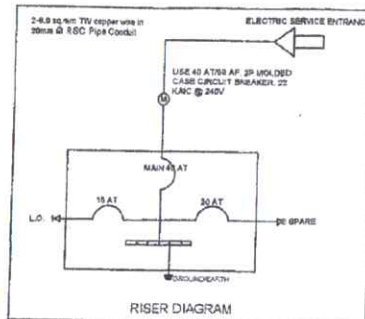
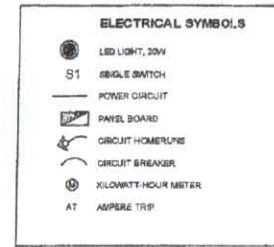

**ELECTRICAL AND SPECIFICATION NOTE:**

1. ALL ELECTRICAL WORKS INDICATED HEREIN SHALL BE DONE IN ACCORDANCE WITH THE LATEST PROVISIONS OF THE LATEST EDITION OF THE PHILIPPINE ELECTRICAL CODE.
2. ALL WIRING FOR POWER AND LIGHTING SHALL BE INSIDE UPVC CONDUIT OF THE APPROVED TYPE.
3. MINIMUM SIZE OF CONDUITS WHEN NOT INDICATED IN THE PLAN OR DRAWINGS SHALL BE 15mm Ø CONDUIT UNLESS OTHERWISE INDICATED.
4. ALTHOUGH NOT SHOWN IN THE PLAN, PROVIDE JUNCTION BOX OR UTILITY BOX WHEN NECESSARY.
5. ALL PIPE INSTALLATION SHALL BE PROVIDED WITH HANGER AND SUPPORT.
6. ALL INSTALLATION SHALL BE DONE IN GOOD AND NEAT WORKMANSHIP.

**ELECTRICAL LAYOUT**  
 Scale: NTS

PREPARED FROM THE OFFICE OF THE: DEPARTMENT OF AGRICULTURE REGIONAL FIELD OFFICE NO. 1 REGIONAL AGRICULTURAL ENGINEERING DIVISION	PROJECT TITLE:	PREPARED BY:	CHECKED & REVIEWED BY:	RECOMMENDING APPROVAL:	APPROVED:	SHEET CONTENTS:	SHEET NO.:
	CONSTRUCTION OF GOAT BREEDER HOUSE	SARAH JANE T. CAYME, ABE REGIONAL OFFICER	MARK HARRY G. PASTOR, ABE CIVIL ENGINEER	DENNIS L. TACTIC, ABE RTO	ANNIE Q. BARES, DVM Regional Extension Director	AS SHOWN	14 15



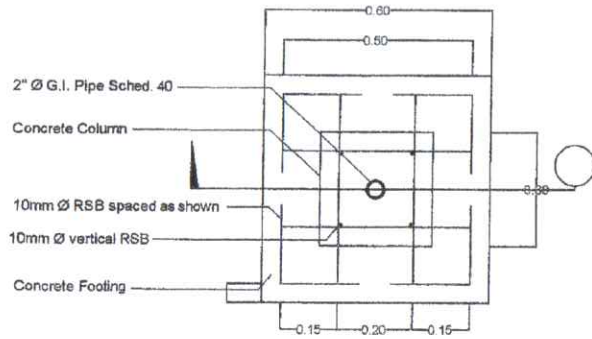



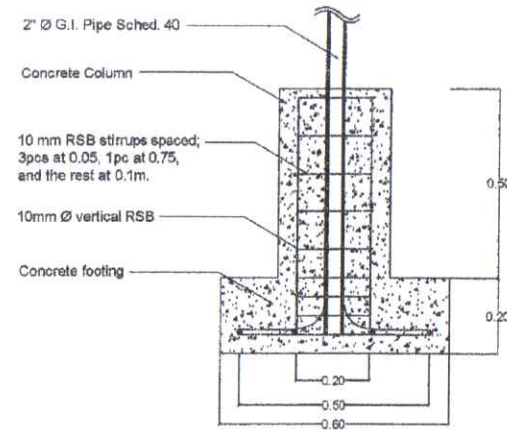

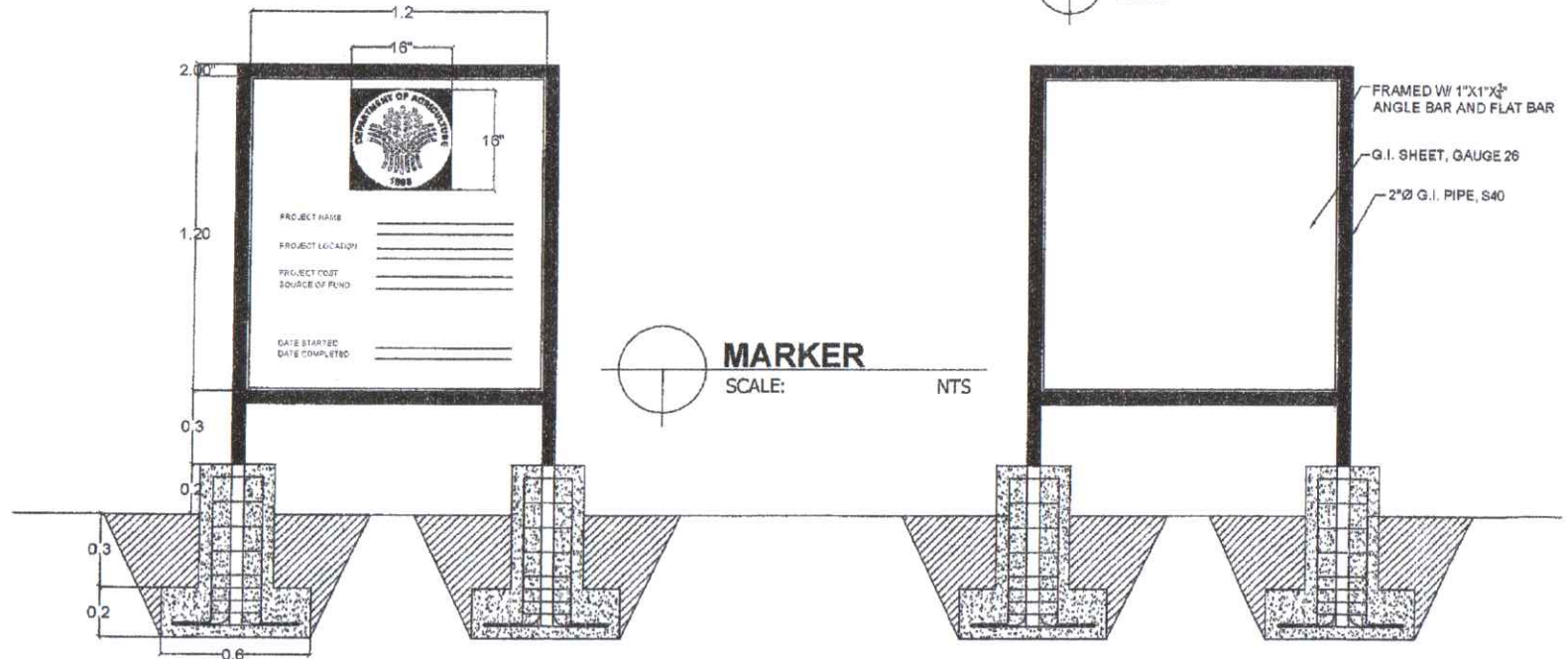

**CONCRETE PEDESTAL**  
SCALE: NTS

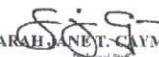

**DETAILS OF SECTION V**  
SCALE: NTS

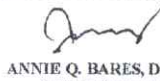

PREPARED FROM THE OFFICE OF THE	PROJECT TITLE	PREPARED BY	CHECKED & REVIEWED BY	RECOMMENDING APPROVAL	APPROVED	SBRY CONTENTS	SHEET NO
 REPUBLIC OF THE PHILIPPINES <b>DEPARTMENT OF AGRICULTURE</b> REGIONAL FIELD OFFICE NO. 1 ANGELES, BULACAN, PANGASINAN DIVISION <b>REGIONAL AGRICULTURAL ENGINEERING DIVISION</b>	<b>CONSTRUCTION OF GOAT BREEDER HOUSE</b> LOCATION: REGION 1	 SARAH JANET CAYME, ABE <i>Regional Eng.</i>	 MARK HARRY PASTOR, ABE <i>Checked</i>	 DENNIS P. ACTA, ABE <i>Regional Executive Deputy</i>	 ANNIE Q. BARES, DVM <i>Regional Executive Deputy</i>		



Republic of the Philippines  
**DEPARTMENT OF AGRICULTURE**  
Regional Field Office No. 1  
Aguila Road, Sevilla, San Fernando City, La Union  
Tel. Nos.: 888-43-05; 888-31-79; 888-2045  
888-0341; 242-10-45 to 10-46

### **SCOPE OF WORK AND SPECIFICATIONS**

**PROJECT NAME:** CONSTRUCTION OF GOAT BREEDER HOUSE  
**LOCATION:** Region 1  
**PROJECT DESCRIPTION:** Construction of Goat Breeder House in support to the Livestock Economic Enterprise and Development (LEED) of the Livestock Banner Program in Region 1

**The Contractor or the implementer is responsible to:**

#### **GENERAL NOTES**

1. Verify all measurements and condition of the site as indicated on the approved site plan, building plans, structural plans, and other drawings prepared by the design engineer. The contractor to notify immediately the end user and engineer with any discrepancies between actual conditions and information shown in the drawing before proceeding with the work.
2. The structural drawings and specifications represent the general framework of the structure. They do not indicate methods of construction, unless so stated, the contractor/implementer shall provide all necessary measures to protect the structure, contractor/ implementer obligation to notify the Structural Engineer/Project Engineer of any conditions that may endanger the stability or cause distress in the structure during phases of construction.
3. Construction materials shall not be stored on poured slabs. It is the general contractor's/implementer's responsibility to ensure that sub-contractors are informed and do not violate this important requirement.
4. The contractor/implementer shall provide temporary erection bracings and shoring for all the structural members as required for stability during phases of work.
5. The contractor/implementer shall take all necessary steps of ensured proper alignment of each member of the structure, avoiding unnecessary eccentricities after the installation of all structural and finished materials.
6. The contractor is responsible to furnish all required materials, labors, equipment, and tools to perform all operations necessary to fabricate, all primary and secondary structural framing members, bolted connections, roof and wall coverings and other items as specified by the contract drawings, manufacturer's requirement and specifications.
7. The contractor shall not remove any excess (unused) construction material from the site without the end user's approval.
8. The contractor is responsible to keep a clean and safe construction area at the end of each work day.

**I. GENERAL REQUIREMENTS (PERMITS & PROJECT BILLBOARD)**

**1.00 lot**

The contractor shall be responsible for securing all necessary permits related to the project, which shall include but not limited to building permits, occupancy permit, etc.).

All related documents shall be submitted to the End User.

The contractor is responsible to secure and obtain information from the regulatory agencies in municipality for all and any other required permits not listed below. A copy of the required permits shall be submitted to the end user within 24 hours of obtaining such permits.

Electrical permit and plans (if required by Building Official), is the contractor's responsibility.

Health department approval and septic connections, contractor's responsibility. Contractor is required to check with the department to obtain information on the required plans and permits, if any.

The new billboard design layout and dimension shall be install on a standard billboard, measuring 1200mm x 2440mm (4' x 8') using 12mm (1/2 inch) thick marine plywood or tarpaulin posted on 5mm (3/16 inch) marine plywood.

For each building project, the billboard shall be installed in front of the project site.

**II. MOBILIZATION AND DEMOBILIZATION**

**1.00 LS**

The Contractor shall provide all labor and equipment costs necessary to move personnel, equipment, supplies and incidentals to and from the Project Site, establish offices, buildings, and other facilities necessary for the Work, obtain bonds, required insurance and any other pre-construction expenses necessary to perform the Work This section shall exclude the cost of construction materials.

**III. PROVISION OF SAFETY AND HEALTH**

**1.00 LS**

Construction workers must be oriented, instructed and trained by the construction project manager to assure safe handling of equipment and of disposing waste. All employees must have protective equipment for the eyes, face, feet and all crucial body parts when exposed to hazardous work procedures. A safety officer is required onsite for every ten units of heavy equipment to ensure proper handling.

**IV. EARTHWORKS**

**42.57 sq.m.**

1. The contractor shall make all necessary excavation for foundations to grade indicated on the drawings. Work that is excavated to a greater extent than required by the drawings and specifications and which is within the bearing area of walls, footings, or floor slabs shall be filled structural specifications. The building foundation shall be staked out

accurately, after which, approval by the Architect/Engineer shall be secured before any excavation work is done. The Contractor shall secure the surrounding properties from all forms of damage and destruction caused by the excavation.

2. NO FOUNDATION shall rest on fill. All excavation shall be done with the proper allowances for floor slabs. All excavation shall be done with the proper allowances for floor slabs, forms and centers. Bottom of foundation shall be approximately level, clean and clear of loose materials and lower sections true to size. All roots, stumps, organic materials and weathered rocks shall be removed and the cavities cleaned and filled with well-compacted sand and gravel.
3. SOIL BEARING capacities of foundation shall be as specified by the Structural engineer. Should the soil at the proposed level of footing bases be found not capable of resisting said pressure, the Architect or the Structural engineer or Project Engineer, shall be notified and they shall revise foundation details as required.
4. Upon completion of foundation no steel reinforcement shall be installed and concrete shall be poured until the contractor has approved the soil for each individual footing. Further supervisions for any indication of weak soil conditions before placing steel reinforcements and concrete.
5. After concrete for foundations is hard enough to withstand pressure resulting from fills, the materials removed from excavations shall be used for backfill around them. Backfill and fills shall be placed in layers not exceeding 150mm in thickness, and each layer shall be thoroughly compacted by wetting, tamping and rolling.

#### V. RSB WORKS

3,594.49 kgs

1. All reinforcement shall be placed in accordance with plans furnished by the Engineer. In case of any doubt or ambiguity in placing of steel, the Contractor shall consult the Engineer whose decision shall be final in such cases.
2. All reinforcing steel bars used shall be new and free from rust, oil, defects, grease or links. All loose rust or scale, adhering materials and all oil or either materials which tend to destroy bond between the concrete and the reinforcement shall be removed before placing the steel and before concreting begins.
3. Metal reinforcement shall be accurately placed and adequately secured by concrete or metal chair spacers. The minimum distance between the parallel bars shall be one and one half times the diameter for round bars and twice the side dimensions for square bars. In no case shall the clear distance between bars shall be less one or more than one and one-third times the minimum size of the coarse aggregates. Where bars are used in two or more layers, the bars in the upper layers at distance of not less than one inch.
4. All steel reinforcing bars shall be accurately placed and secured against displacement by tying them together at each bar intersection with Gauge No. 16 galvanized iron wire.
5. All main reinforcing steel used in the structure shall conform to ASTM Grade 40 (Intermediate Grade) with yield strength of 40 ksi (276 MPa).
6. All temperature bars shall conform to ASTM Grade 30 Structural Grade with minimum yield strength of 30 ksi (207 MPa).

The materials to be used are the following:

16 mm Dia. X 6 m RSB  
12 mm Dia. X 6 m RSB  
10 mm Dia. X 6 m RSB  
Tie wire #16

**VI. FORMWORKS AND SCAFDOLDINGS**

**520.00 bd.ft.**

1. Provide forms that will produce correctly aligned concrete. Column and beam forms shall be checked from plumpness before concrete is deposited. Hand holes shall be provided in the column forms at lowest points of pour lifts to render this spaces accessible for clearing.
2. Joints in form shall be horizontal or vertical. Lumber once used in form shall be nailed withdrawn and surfaces to be in contact with concrete shall be thoroughly wetted with water in advance of pouring. Woods to be used shall be kiln dried and treated with anti-termite chemical. And all lumber surfaces in contact with concrete shall receive one brush of bituminous part.
3. Immediately after the removal of the form, all project wires and bolts and other devices used for holding form shall be cut off at least one-half centimeter beneath the finished surfaces. All holes and defects shall be thoroughly wetted and then painted up solid with cement putty mortar of the same proportions as the mortar used in the body of the works.
4. All parts protruding beyond the surfacing shall be treated in such manner as to effectively remove all the lines and marks impressed by the form works.
5. Forms shall be removed in a manner which will prevent damage to the concrete ans shall not be removed earlier than the bottom forms but additional posts or shoring must be placed under the beams or girders until they have attained strength. Forms shall not be removed until approval of the Design Engineer. Any repair of surface imperfections shall be performed at once and airing shall be started as soon as the surface is sufficiently hard to permit it without further damage.

**VII. CONCRETE WORKS**

**17.12 cu.m.**

1. Materials

Fine aggregates shall be clean, well graded, hard, natural sand or manufactured sand or a combination of both. The maximum size of the aggregates shall not be larger than one-fifth (1/5) of the narrowest dimension between forms and not larger than three-fourths (3/4) of the minimum clear spacing between reinforcing bars, and in no case larger than two inches in diameter. Coarse aggregates shall be hard, durable, uncoated gravel, crushed gravel, free from any deleterious materials like alkali, loam, silt and any organic matter.

Water used in making the concrete mass shall reasonably clean, potable, and free from injurious amount of oils, acids, alkali organic materials and other deleterious substances.

2. Mixing Concrete

**VIII. STEEL WORKS (ROOF AND RAMP & RAILING)****438.00 kgs**

1. All angle bar to be used shall have a minimum yield strength of 227.60 MPa.
2. The steel truss (ST) shall be made up of 2"x2"x3/16" angle bars. Lateral Truss shall be made up of 2"x2"x3/16" angle bars and for the members 1 1/2"x 1 1/2"x1/8" angle bar
3. Ramp & Railing materials shall conform according to the plan

**IX. TINSMITHRY WORKS****157.20 sq.m.**

1. The roof to be used is Pre-Painted 0.6 mm Rib Type Gauge 26. All sheets to be supported at both ends, at the middle end laps to be properly secured. Side laps should also be properly secured. Rivets should always come at the ridge and not the valley of the ridge and hips shall be lapped wide enough to prevent walls for leaking. Flashing shall be done according to standard procedures in securing non-leakage and or capillary action of water through joints and laps.

**X. FLOOR, STEEL RAILING AND FEEDING TROUGH WORKS****72.00 sq.m.**

1. The Contractor shall verify structures prior to construction.
2. A floor framing of 2"x3" Good Lumber and 2"x5" Good Lumber is used to secure the plastic matting flooring. Plastic matting flooring must be secured with 3" Tec Screw.
3. Plastic matting flooring must be 1' x2' by 1/2 thk and d5/8 inch square holes of plastic matting
4. Divisional Fence is made of 8x8mm square bar, welded at a space of .10 m and framed with 1 1/2 GI Pipe SG 40 . All openings are hinged and locked with fabricated ring lock is made of 15mm x 3mm thk Flat Bar.

**XI. PLUMBING WORKS****1.00 lot**

1. Pipe laying, pipe trenches shall be laid true to line and grade on stable and suitable prepared foundations. Piping to all outlets, and equipment from the gate valve. All pipes shall be cut accurately to measurements, and worked into place without springing or forcing. Care shall be taken as not weaken structural portion of the building.

**XII. PERIMETER FENCE****120 Meters****A. EARTHWORKS**

1. The contractor shall make all necessary excavation for foundations to grade indicated on the drawings. Work that is excavated to a greater extent than required by the drawings and specifications and which is within the bearing area of walls, footings, or floor slabs shall be filled structural specifications. The building foundation shall be staked out accurately, after which, approval by the Architect/Engineer shall be secured before any excavation work is done. The Contractor shall secure the surrounding properties from all forms of damage and destruction caused by the excavation.

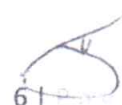

2. NO FOUNDATION shall rest on fill. All excavation shall be done with the proper allowances for floor slabs. All excavation shall be done with the proper allowances for floor slabs, forms and centers. Bottom of foundation shall be approximately level, clean and clear of loose materials and lower sections true to size. All roots, stumps, organic materials and weathered rocks shall be removed and the cavities cleaned and filled with well-compacted sand and gravel.
3. SOIL BEARING capacities of foundation shall be as specified by the Structural engineer. Should the soil at the proposed level of footing bases be found not capable of resisting said pressure, the Architect or the Structural engineer or Project Engineer, shall be notified and they shall revise foundation details as required.
4. Upon completion of foundation no steel reinforcement shall be installed and concrete shall be poured until the contractor has approved the soil for each individual footing. Further supervisions for any indication of weak soil conditions before placing steel reinforcements and concrete.
5. After concrete for foundations is hard enough to withstand pressure resulting from fills, the materials removed from excavations shall be used for backfill around them. Backfill and fills shall be placed in layers not exceeding 150mm in thickness, and each layer shall be thoroughly compacted by wetting, tamping and rolling.

#### **B. RSB WORKS WITH CYCLONE WIRE**

1. All reinforcement shall be placed in accordance with plans furnished by the Engineer. In case of any doubt or ambiguity in placing of steel, the Contractor shall consult the Engineer whose decision shall be final in such cases.
2. All reinforcing steel bars used shall be new and free from rust, oil, defects, grease or links. All loose rust or scale, adhering materials and all oil or either materials which tend to destroy bond between the concrete and the reinforcement shall be removed before placing the steel and before concreting begins.
3. Metal reinforcement shall be accurately placed and adequately secured by concrete or metal chair spacers. The minimum distance between the parallel bars shall be one and one half times the diameter for round bars and twice the side dimensions for square bars. In no case shall the clear distance between bars shall be less one or more than one and one-third times the minimum size of the coarse aggregates. Where bars are used in two or more layers, the bars in the upper layers at distance of not less than one inch.
4. All steel reinforcing bars shall be accurately placed and secured against displacement by tying them together at each bar intersection with Gauge No. 16 galvanized iron wire.
5. All main reinforcing steel used in the structure shall conform to ASTM Grade 40 (Intermediate Grade) with yield strength of 40 ksi (276 MPa).
6. All temperature bars shall conform to ASTM Grade 30 Structural Grade with minimum yield strength of 30 ksi (207 MPa).

The materials to be used are the following:

Cyclone Wire 3.4 mm x 2"x5'x6m  
10 mm Dia. X 6 m RSB  
Tie wire #16

## C. CONCRETE WORKS

### 1. Materials

Fine aggregates shall be clean, well graded, hard, natural sand or manufactured sand or a combination of both. The maximum size of the aggregates shall not be larger than one-fifth (1/5) of the narrowest dimension between forms and not larger than three-fourths (3/4) of the minimum clear spacing between reinforcing bars, and in no case larger than two inches in diameter. Coarse aggregates shall be hard, durable, uncoated gravel, crushed gravel, free from any deleterious materials like alkali, loam, silt and any organic matter.

Water used in making the concrete mass shall reasonably clean, potable, and free from injurious amount of oils, acids, alkali organic materials and other deleterious substances.

### 2. Mixing Concrete

No hand mixing shall be allowed except in cases of emergency such as mixer breakdown during pouring operations and shall stop at the first allowed construction joint. All concrete shall be machine-mixed for at least one and one-half minutes after all materials, including water, are in the mixing drum.

The mixer shall be of approved size and type which will ensure a uniform distribution of materials throughout the mass. It shall be equipped with a device for accurately measuring and controlling the amount of water in each batch.

The first batch of concrete materials placed in the mixer shall contain a sufficient excess of cement, sand and water to coat inside of the drum without reducing the cement content of the mix to be discharged.

### 3. Specified Compressive Strength

Class	Psi	MPa
AA	4,000	27.57
A	3,000	20.68
B	2,500	17.23
C	2,000	13.78

- Class A: For, beams, columns and footing, ramp up, flooring @ NGL and for all reinforced work not otherwise indicated or specified.

### 4. Conveying and Placing of Concrete

Concrete shall be conveyed from mixer to form as rapidly as practicable. There will be no vertical drop greater than 1.50 meters except where suitable equipment is provided to prevent segregation and where specifically authorized by the Architect and or the Structural Engineer or Project Engineer.

Concrete shall be worked readily into the corners and angles of the forms and around all reinforcements and embedded items without permitting materials to segregate. Concrete shall be deposited as close as possible to its final position so that flow within the mass does not exceed two meters and consequently segregation is reduced to a minimum near forms or embedded items, or elsewhere is directed, the discharge shall be so controlled



that the concrete may be effectively connected into horizontal layers not exceeding 30 centimeters in depth within the maximum lateral movement specified.

In placing concrete through reinforcement, care shall be taken that no segregation of the coarse aggregate occurs. On the bottom of beams and slabs, where the congestion of steel near the forms makes placing difficult, a layer of mortar of the same cement-sand ratios as used in concrete shall be first deposited to cover the surfaces.

#### 5. Curing

Compressive strength of concrete at 28 days curing period shall attain 3000 psi (20.7 MPa) with well graded aggregates having a maximum size of 2 inches (50mm).

### XIII. ELECTRICAL WORKS

1.00 lot

#### 1. General

- All electrical works for the building will be done in accordance with the provisions of Latest Philippine National Electronic Code and the rules and regulations of the Electrical Ordinance of the Municipality, and rules and regulations of other governing authorities.

#### 2. Materials

- The contractor shall install/ replace all materials as present in the existing structure. Install all equipment and materials in a neat and professional manner. Leave all exposed parts of the electrical works in a neat, clean and usable condition, with painted surfaces unblemished and polished surface re polished. Panel boards to be used shall be flush mounted when located in areas that are visible.
- All lighting fixtures shall be proved and installed of the sizes and type as indicated on the approved plans and drawings. Fixtures units shall be completed. Junction box and utility box are PVC and "POLY" brand will be used. The bulb shall be accessible without removing the fixtures. All wiring shall be installed, in general, concealed in the the structure except as noted ir as required.

### XIV. INSTALLATION OF PROJECT MARKER

1.00 lot.

Installation of the project marker shall be constructed as shown on the detailed plans. Synthetic enamels paint shall be used for the project details letterings and logo.

The above specifications are intended for the **CONSTRUCTION OF GOAT BREEDER HOUSE IN REGION 1.**

Prepared by:

  
**BENJAY P. PAREJA ABE**  
Engineer II

Concurred by:

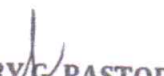
  
**MARK HARRY G. PASTOR ABE**  
Chief, RAED

**DEPARTMENT OF AGRICULTURE-REGIONAL FIELD OFFICE 1**  
*NAME OF PROCURING ENTITY*

PROJECT REFERENCE NO.: \_\_\_\_\_  
 NAME OF PROJECT: \_\_\_\_\_

**STATEMENT OF ALL ON-GOING GOVERNMENT AND PRIVATE CONTRACTS, INCLUDING CONTRACTS AWARDED BUT NOT YET STARTED, IF ANY, WHETHER SIMILAR OR NOT SIMILAR IN NATURE AND COMPLEXITY TO THE CONTRACT TO BE BID**

**CONTRACT TO BE BID:** \_\_\_\_\_  
**BUSINESS NAME:** \_\_\_\_\_  
**BUSINESS ADDRESS:** \_\_\_\_\_

Name of Contract/ Location Project Cost	a. Owner's Name b. Address c. Telephone Nos.	NATURE OF WORK	CONTRACTOR'S ROLE		a. Date Awarded b. Date Started c. Date Completion	% Accomplishment		Value of Outstanding Works
			Description	%		Planned	Actual	

Note: This statement shall be supported with:  
 1. Notice of Award and/or Contract  
 2. Notice to Proceed issued by the Owner

Submitted by:

Name of Representative of Bidder  
Position  
 Date: \_\_\_\_\_

**Statement identifying the Bidder's Single Largest Completed Contract (SLCC) similar in nature**

Contract to be Bid: \_\_\_\_\_  
 Business Name: \_\_\_\_\_  
 Business Address: \_\_\_\_\_

Name of Client	a. Owner's Name b. Address c. Telephone Nos.	Title of the Project in the Contract	Nature of Work	a. Date Awarded b. Contract Effectivity c. Date Completed	Contractor's Role (whether sole contractor, subcontractor, or partner in a JV)		a. Total Contract Value at Award b. Total Contract Value at Completion c. Contract Duration
					Description	%	
<u>Government</u>							
<u>Private</u>							

Note: This statement shall be supported with:

1. Notice of Award
2. Notice to Proceed
3. Contract
4. Owner's Certificate of Acceptance OR Constructors Performance Evaluation Summary (CPES) Rating

Submitted by : \_\_\_\_\_  
 (Printed Name and Signature)  
 Designation : \_\_\_\_\_  
 Date : \_\_\_\_\_

## **Bid Securing Declaration Form**

*[shall be submitted with the Bid if bidder opts to provide this form of bid security]*

---

REPUBLIC OF THE PHILIPPINES)  
CITY OF \_\_\_\_\_) S.S.

### **BID SECURING DECLARATION** **Project Identification No.: *[Insert number]***

To: **DEPARTMENT OF AGRICULTURE REGIONAL FIELD OFFICE 1**  
**City of San Fernando, La Union**

I/We, the undersigned, declare that:

1. I/We understand that, according to your conditions, bids must be supported by a Bid Security, which may be in the form of a Bid Securing Declaration.
2. I/We accept that: (a) I/we will be automatically disqualified from bidding for any procurement contract with any procuring entity for a period of two (2) years upon receipt of your Blacklisting Order; and, (b) I/we will pay the applicable fine provided under Section 6 of the Guidelines on the Use of Bid Securing Declaration, within fifteen (15) days from receipt of the written demand by the procuring entity for the commission of acts resulting to the enforcement of the bid securing declaration under Sections 23.1(b), 34.2, 40.1 and 69.1, except 69.1(f), of the IRR of RA No. 9184; without prejudice to other legal action the government may undertake.
3. I/We understand that this Bid Securing Declaration shall cease to be valid on the following circumstances:
  - a. Upon expiration of the bid validity period, or any extension thereof pursuant to your request;
  - b. I am/we are declared ineligible or post-disqualified upon receipt of your notice to such effect, and (i) I/we failed to timely file a request for reconsideration or (ii) I/we filed a waiver to avail of said right; and
  - c. I am/we are declared the bidder with the Lowest Calculated Responsive Bid, and I/we have furnished the performance security and signed the Contract.

IN WITNESS WHEREOF, I/We have hereunto set my/our hand/s this \_\_\_\_ day of *[month]* *[year]* at *[place of execution]*.

*[Insert NAME OF BIDDER OR ITS AUTHORIZED  
REPRESENTATIVE  
[Insert signatory's legal capacity]  
Affiant*

***[Jurat]***

*[Format shall be based on the latest Rules on Notarial Practice]*

**DEPARTMENT OF AGRICULTURE-REGIONAL FIELD OFFICE 1**

NAME OF PROCURING ENTITY \_\_\_\_\_

Standard Form Number: SF-INFR-48  
 Revised on: August 11, 2004

Contract Reference No.: \_\_\_\_\_

Name of the Contract: \_\_\_\_\_

Location of the Contract: \_\_\_\_\_

**(LIST) Qualification of Key Personnel Proposed to be Assigned to the Contract**

Business Name: \_\_\_\_\_

Business Address: \_\_\_\_\_

		Project Manager/Engineer	Materials Engineer	Foreman	Construction Safety and Health Personnel	Other positions deemed required by the Applicant for the project
1	Name					
2	Address					
3	Date of Birth					
4	Employed since					
5	Experience					
6	Previous Employment					
7	Education					
8	PRC Licence					

Minimum Requirements : Project Manager/Engineer  
 : Materials Engineer  
 : Foreman  
 : Foreman

Note : Attached individual resume and PRC License of the (professional) personnel

Submitted by : \_\_\_\_\_  
 (Printed Name and Signature)

Designation : \_\_\_\_\_

Date : \_\_\_\_\_

*One of the requirements from the bidder to be included in its Technical Envelope is a list of contractor's key personnel (viz, Project Manager, Project Engineers, Materials Engineers and Foremen), to be assigned to the contract to be bid, with their complete qualification and experience data (including the key personnel signed written commitment to work for the project once awarded the contract).*

**DEPARTMENT OF AGRICULTURE-REGIONAL FIELD OFFICE 1**  
*NAME OF PROCURING ENTITY*

Contract Reference Number  
Name of the Contract  
Location of the Contract

1. Name : \_\_\_\_\_
2. Name and Address of Owner : \_\_\_\_\_
3. Name and Address of the  
Owner's Engineer : \_\_\_\_\_  
(Consultant)
- 3-4. Indicate the Features of Project  
(particulars of the project  
Components and any other particular  
Interest connected with the project): \_\_\_\_\_
5. Contract Amount Expressed in  
Philippine currency : \_\_\_\_\_
6. Position : \_\_\_\_\_
7. Structures for which the employee  
was responsible : \_\_\_\_\_
8. Assignment Period : from \_\_\_\_\_ (months)  
: to \_\_\_\_\_ (months)

\_\_\_\_\_  
Name and Signature of Employee

It is hereby certified that the above personnel can be assigned to this project, if the contract is awarded to our company.

\_\_\_\_\_  
(Place and Date)

\_\_\_\_\_  
(The Authorized Representative)

*One of the requirements from the bidder to be included in its Technical Envelope is a list of contractor's key personnel (viz, Project Manager, Project Engineers, Materials Engineers and Foremen), to be assigned to the contract to be bid, with their complete qualification and experience data (including the key personnel signed written commitment to work for the project once awarded the contract).* \_\_\_\_\_ **SF-INFR-47b**

Standard Form Number: SF-INFR-47  
Revised on: August 11, 2004

**KEY PERSONNEL**  
**(FORMAT OF BIO-DATA)**

Give the detailed information of the following personnel who are to be assigned as full-time field staff for the project. Fill up a form for each person.

- Authorized Managing Officer/Representative
- Sustained Technical Employee

1. Name	:	_____
2. Date of Birth	:	_____
3. Nationality	:	_____
4. Education and Degrees	:	_____
5. Specialty	:	_____
6. Registration	:	_____
7. Length of service with the Firm	:	_____
8. Years of Experience	:	_____

9. If item 7 is less than ten (10) years, give name and length of service with previous employers for a ten (10)-year period (attach additional sheet/s), if necessary:

<u>Name and Address of employer</u>	<u>Length of Service</u>
_____	_____ year(s) from _____ to _____
_____	_____ year(s) from _____ to _____
_____	_____ year(s) from _____ to _____

10. Experience:

This should cover the past ten (10) years of experience. (Attach as many pages as necessary to show involvement of personnel in projects using the format below).

*One of the requirements from the bidder to be included in its Technical Envelope is a list of contractor's key personnel (viz, Project Manager, Project Engineers, Materials Engineers and Foremen), to be assigned to the contract to be bid, with their complete qualification and experience data (including the key personnel signed written commitment to work for the project once awarded the contract).* \_\_\_\_\_ SF-INFR-47a

**DEPARTMENT OF AGRICULTURE-REGIONAL FIELD OFFICE 1**  
**NAME OF PROCURING ENTITY**

Contract Reference Number  
Name of the Contract  
Location of the Contract

Standard Form Number: SF-INFR-46  
Revised on: August 11, 2004

**Key Personnel's Certificate of Employment**

Issuance Date

DIR. NESTOR

Position of the Head of the Procuring Entity

DEPARTMENT OF AGRICULTURE REGIONAL FIELD OFFICE 1

CITY OF SAN FERNANDO, LA UNIONO

Dear Sir/Madame:

I am (Name of Nominee) a Licensed \_\_\_\_\_ Engineer with Professional License No. \_\_\_\_\_ issued on (Date of Issuance) at (place of issuance) .

I hereby certify that (Name of Bidder) has engaged my services as (designation) for (name of the Contract), if awarded to it.

As (designation), I supervised the following completed projects similar to the contract under bidding:

NAME OF PROJECT	OWNER	COST	DATE COMPLETED
_____	_____	_____	_____
_____	_____	_____	_____
_____	_____	_____	_____
_____	_____	_____	_____

At present, I am supervising the following projects:

NAME OF PROJECT	OWNER	COST	DATE COMPLETED
_____	_____	_____	_____
_____	_____	_____	_____
_____	_____	_____	_____
_____	_____	_____	_____

In case of my separation for any reason whatsoever from the above-mentioned contractor, I shall notify the (Name of the Procuring Entity) at least twenty one (21) days before the effective date of my separation.

As (Designation), I know I will have to stay in the job site all the time to supervise and manage the Contract works to the best of my ability, and aware that I am authorized to hanle only one (1) contract at a time.

I do not allow the use of my name for the purpose of enabling the above-mentioned Contractor to qualify for the Contract without any firm commitment on my part to assume the post of (Designation) thereof, if the contract is awarded to him since I understand that to do so will be



a sufficient ground for my disqualification as (Designation) in any future  (Name of the Procuring Entity)  bidding or employment with any Contractor doing business with the  Name of the Procuring Entity .

\_\_\_\_\_  
(Signature of Engineer)

DRY SEAL

Republic of the Philippines )  
\_\_\_\_\_ ) S.S.

SUBSCRIBED AND SWORN TO before me this \_\_\_\_\_ day of \_\_\_\_\_ 2022 affiant exhibiting to me his/her Residence Certificate No. \_\_\_\_\_ issued on \_\_\_\_\_ at \_\_\_\_\_.

Notary Public  
Until December 31, 20\_\_\_\_\_

Doc. No. \_\_\_\_\_  
Page No. \_\_\_\_\_  
Book No. \_\_\_\_\_  
Series of \_\_\_\_\_

*One of the requirements from the bidder to be included in its Technical Envelope is a list of contractor's key personnel (viz, Project Manager, Project Engineers, Materials Engineers and Foremen), to be assigned to the contract to be bid, with their complete qualification and experience data (including the key personnel signed written commitment to work for the project once awarded the contract).* \_\_\_\_\_ SF-INFR-46a

Standard Form Number: SF-INFR-49

Revised on August 11, 2004

**LIST OF EQUIPMENT, OWNED OF LEASED and/or under PURCHASE AGREEMENT, PLEDGED TO THE PROPOSED PROJECT**

Business Name : \_\_\_\_\_  
Business Address : \_\_\_\_\_

Description	Model/Year	Capacity/ Performance/ Size	Plate No.	Motor No./ Body No.	Location	Condition	Proof of Ownership/ Lessor or Vendor

List of minimum equipment required for the project

Submitted by : \_\_\_\_\_  
(Print name and affix signature)  
Designation : \_\_\_\_\_  
Date : \_\_\_\_\_

## Omnibus Sworn Statement (Revised)

*[shall be submitted with the Bid]*

---

REPUBLIC OF THE PHILIPPINES )  
CITY/MUNICIPALITY OF \_\_\_\_\_ ) S.S.

### AFFIDAVIT

I, [Name of Affiant], of legal age, [Civil Status], [Nationality], and residing at [Address of Affiant], after having been duly sworn in accordance with law, do hereby depose and state that:

1. *[Select one, delete the other:]*

*[If a sole proprietorship:]* I am the sole proprietor or authorized representative of [Name of Bidder] with office address at [address of Bidder];

*[If a partnership, corporation, cooperative, or joint venture:]* I am the duly authorized and designated representative of [Name of Bidder] with office address at [address of Bidder];

2. *[Select one, delete the other:]*

*[If a sole proprietorship:]* As the owner and sole proprietor, or authorized representative of [Name of Bidder], I have full power and authority to do, execute and perform any and all acts necessary to participate, submit the bid, and to sign and execute the ensuing contract for [Name of the Project] of the [Name of the Procuring Entity], as shown in the attached duly notarized Special Power of Attorney;

*[If a partnership, corporation, cooperative, or joint venture:]* I am granted full power and authority to do, execute and perform any and all acts necessary to participate, submit the bid, and to sign and execute the ensuing contract for [Name of the Project] of the [Name of the Procuring Entity], as shown in the attached [state title of attached document showing proof of authorization (e.g., duly notarized Secretary's Certificate, Board/Partnership Resolution, or Special Power of Attorney, whichever is applicable)];

3. [Name of Bidder] is not "blacklisted" or barred from bidding by the Government of the Philippines or any of its agencies, offices, corporations, or Local Government Units, foreign government/foreign or international financing institution whose blacklisting rules have been recognized by the Government Procurement Policy Board, **by itself or by relation, membership, association, affiliation, or controlling interest with another blacklisted person or entity as defined and provided for in the Uniform Guidelines on Blacklisting;**

4. Each of the documents submitted in satisfaction of the bidding requirements is an authentic copy of the original, complete, and all statements and information provided therein are true and correct;

5. [Name of Bidder] is authorizing the Head of the Procuring Entity or its duly authorized representative(s) to verify all the documents submitted;

6. *[Select one, delete the rest:]*

*[If a sole proprietorship:]* The owner or sole proprietor is not related to the Head of the Procuring Entity, members of the Bids and Awards Committee (BAC), the

Technical Working Group, and the BAC Secretariat, the head of the Project Management Office or the end-user unit, and the project consultants by consanguinity or affinity up to the third civil degree;

[If a partnership or cooperative] None of the officers and members of [Name of Bidder] is related to the Head of the Procuring Entity, members of the Bids and Awards Committee (BAC), the Technical Working Group, and the BAC Secretariat, the head of the Project Management Office or the end-user unit, and the project consultants by consanguinity or affinity up to the third civil degree;

7. *[Name of Bidder]* complies with existing labor laws and standards; and
8. *[Name of Bidder]* is aware of and has undertaken the responsibilities as a Bidder in compliance with the Philippine Bidding Documents, which includes:
  - a. Carefully examining all of the Bidding Documents;
  - b. Acknowledging all conditions, local or otherwise, affecting the implementation of the Contract;
  - c. Making an estimate of the facilities available and needed for the contract to be bid, if any; and
  - d. Inquiring or securing Supplemental/Bid Bulletin(s) issued for the *[Name of the Project]*.
9. *[Name of Bidder]* did not give or pay directly or indirectly, any commission, amount, fee, or any form of consideration, pecuniary or otherwise, to any person or official, personnel or representative of the government in relation to any procurement project or activity.
10. **In case advance payment was made or given, failure to perform or deliver any of the obligations and undertakings in the contract shall be sufficient grounds to constitute criminal liability for Swindling (Estafa) or the commission of fraud with unfaithfulness or abuse of confidence through misappropriating or converting any payment received by a person or entity under an obligation involving the duty to deliver certain goods or services, to the prejudice of the public and the government of the Philippines pursuant to Article 315 of Act No. 3815 s. 1930, as amended, or the Revised Penal Code.**

**IN WITNESS WHEREOF**, I have hereunto set my hand this \_\_\_ day of \_\_\_, 20\_\_ at \_\_\_\_\_, Philippines.

*[Insert NAME OF BIDDER OR ITS AUTHORIZED REPRESENTATIVE]*

*[Insert signatory's legal capacity]*

Affiant

**[Jurat]**

*[Format shall be based on the latest Rules on Notarial Practice]*

**COMPUTATION OF NET FINANCIAL CONTRACTING CAPACITY (NFCC)**

Summary of the Applicant Supplier’s/Distributor’s assets and liabilities on the basis of the attached Income Tax Return and Audited Financial Statement, stamped “RECEIVED” by the Bureau of Internal Revenue or BIR authorized collecting agent for the immediately preceding year.

		Year 20__
1	Total Assets	
2	Current Assets	
3	Total Liabilities	
4	Current Liabilities	
5	Net Worth (1-3)	
6	Net Working Capital (2-4)	

The Net Financial Contracting Capacity (NFCC), which must be at least equal to the ABC to be bid, based on the above data is calculated as follows:

**NFCC** = [(Current asset minus current liabilities) (15)] minus the value of all outstanding or uncompleted portions of the projects under ongoing contracts, including awarded contracts yet to be started

Or,

If the prospective bidder opts to submit a Committed Line of Credit (CLC), it must be at least equal to ten percent (10%) of the ABC to be bid and shall be confirmed or authenticated by a local universal or commercial bank.

Name of Bank \_\_\_\_\_ Amount \_\_\_\_\_

Herewith attached are certified true copies of the Income Tax Return and Audited Financial Statement Stamped “RECEIVED” by the BIR authorized collecting agent for the immediately preceding year.

Submitted by:

*Name of Supplier/Distributor/Manufacturer*

*Printed Name and Signature of Authorized Representative*

*Date:*

# Bid Form for the Procurement of Infrastructure Projects

*[shall be submitted with the Bid]*

---

## BID FORM

Date: \_\_\_\_\_

Project Identification No.: \_\_\_\_\_

To: **DEPARTMENT OF AGRICULTURE REGIONAL FIELD OFFICE 1**  
*City of San Fernando, La Union*

Having examined the Philippine Bidding Documents (PBDs) including the Supplemental or Bid Bulletin Numbers [insert numbers], the receipt of which is hereby duly acknowledged, we, the undersigned, declare that:

- a. We have no reservation to the PBDs, including the Supplemental or Bid Bulletins, for the Procurement Project: *[insert name of contract]*;
- b. We offer to execute the Works for this Contract in accordance with the PBDs;
- c. The total price of our Bid in words and figures, excluding any discounts offered below is: *[insert information]*;
- d. The discounts offered and the methodology for their application are: *[insert information]*;
- e. The total bid price includes the cost of all taxes, such as, but not limited to: *[specify the applicable taxes, e.g. (i) value added tax (VAT), (ii) income tax, (iii) local taxes, and (iv) other fiscal levies and duties]*, which are itemized herein and reflected in the detailed estimates,
- f. Our Bid shall be valid within the period stated in the PBDs, and it shall remain binding upon us at any time before the expiration of that period;
- g. If our Bid is accepted, we commit to obtain a Performance Security in the amount of *[insert percentage amount]* percent of the Contract Price for the due performance of the Contract, or a Performance Securing Declaration in lieu of the allowable forms of Performance Security, subject to the terms and conditions of issued GPPB guidelines<sup>12</sup> for this purpose;
- h. We are not participating, as Bidders, in more than one Bid in this bidding process, other than alternative offers in accordance with the Bidding Documents;
- i. We understand that this Bid, together with your written acceptance thereof included in your notification of award, shall constitute a binding contract between us, until a formal Contract is prepared and executed; and
- j. We understand that you are not bound to accept the Lowest Calculated Bid or any other Bid that you may receive.

- k. We likewise certify/confirm that the undersigned, is the duly authorized representative of the bidder, and granted full power and authority to do, execute and perform any and all acts necessary to participate, submit the bid, and to sign and execute the ensuing contract for the *[Name of Project]* of the *[Name of the Procuring Entity]*.
  
- l. We acknowledge that failure to sign each and every page of this Bid Form, including the Bill of Quantities, shall be a ground for the rejection of our bid.

Name: \_\_\_\_\_

Legal capacity: \_\_\_\_\_

Signature: \_\_\_\_\_

Duly authorized to sign the Bid for and behalf of: \_\_\_\_\_

Date: \_\_\_\_\_