

PHILIPPINE BIDDING DOCUMENTS

Procurement of INFRASTRUCTURE PROJECTS

Government of the Republic of the Philippines

**PROVISION OF LABOR, MATERIALS,
EQUIPMENT RENTAL AND OTHER
INCIDENTALS NEEDED FOR THE
CONSTRUCTION OF PERIMETER FENCE
WITH GATE, WAITING SHED AND GUARD
HOUSE AT DA-ISREC, SAN JUAN, ILOCOS SUR**

IB No.: DA-RFO 1-2025-INFRA-016

**Sixth Edition
July 2020**

TABLE OF CONTENTS

| | |
|--|-----------|
| Glossary of Terms, Abbreviations, and Acronyms..... | 4 |
| Section I. Invitation to Bid | 7 |
| Section II. Instructions to Bidders..... | 8 |
| 1. Scope of Bid..... | 12 |
| 2. Funding Information | 12 |
| 3. Bidding Requirements..... | 12 |
| 4. Corrupt, Fraudulent, Collusive, Coercive, and Obstructive Practices | 12 |
| 5. Eligible Bidders..... | 13 |
| 6. Origin of Associated Goods | 13 |
| 7. Subcontracts | 13 |
| 8. Pre-Bid Conference..... | 13 |
| 9. Clarification and Amendment of Bidding Documents..... | 13 |
| 10. Documents Comprising the Bid: Eligibility and Technical Components..... | 14 |
| 11. Documents Comprising the Bid: Financial Component | 14 |
| 12. Alternative Bids | 15 |
| 13. Bid Prices | 15 |
| 14. Bid and Payment Currencies..... | 15 |
| 15. Bid Security..... | 15 |
| 16. Sealing and Marking of Bids..... | 15 |
| 17. Deadline for Submission of Bids | 16 |
| 18. Opening and Preliminary Examination of Bids | 16 |
| 19. Detailed Evaluation and Comparison of Bids..... | 16 |
| 20. Post Qualification..... | 16 |
| 21. Signing of the Contract | 17 |
| Section III. Bid Data Sheet..... | 18 |
| Section IV. General Conditions of Contract | 20 |
| 1. Scope of Contract..... | 21 |
| 2. Sectional Completion of Works | 21 |
| 3. Possession of Site..... | 21 |
| 4. The Contractor’s Obligations..... | 21 |
| 5. Performance Security | 22 |
| 6. Site Investigation Reports | 22 |

| | | |
|-----|--|-----------|
| 7. | Warranty..... | 22 |
| 8. | Liability of the Contractor..... | 22 |
| 9. | Termination for Other Causes..... | 22 |
| 10. | Dayworks | 23 |
| 11. | Program of Work..... | 23 |
| 12. | Instructions, Inspections and Audits | 23 |
| 13. | Advance Payment..... | 23 |
| 14. | Progress Payments | 23 |
| 15. | Operating and Maintenance Manuals..... | 24 |
| | Section V. Special Conditions of Contract..... | 25 |
| | Section VI. Specifications | 27 |
| | Section VII. Drawings..... | 28 |
| | Section VIII. Bill of Quantities | 29 |
| | Section IX. Checklist of Technical and Financial Documents..... | 30 |

Glossary of Terms, Abbreviations, and Acronyms

ABC – Approved Budget for the Contract.

ARCC – Allowable Range of Contract Cost.

BAC – Bids and Awards Committee.

Bid – A signed offer or proposal to undertake a contract submitted by a bidder in response to and in consonance with the requirements of the bidding documents. Also referred to as *Proposal* and *Tender*. (2016 revised IRR, Section 5[c])

Bidder – Refers to a contractor, manufacturer, supplier, distributor and/or consultant who submits a bid in response to the requirements of the Bidding Documents. (2016 revised IRR, Section 5[d])

Bidding Documents – The documents issued by the Procuring Entity as the bases for bids, furnishing all information necessary for a prospective bidder to prepare a bid for the Goods, Infrastructure Projects, and/or Consulting Services required by the Procuring Entity. (2016 revised IRR, Section 5[e])

BIR – Bureau of Internal Revenue.

BSP – Bangko Sentral ng Pilipinas.

CDA – Cooperative Development Authority.

Consulting Services – Refer to services for Infrastructure Projects and other types of projects or activities of the GOP requiring adequate external technical and professional expertise that are beyond the capability and/or capacity of the GOP to undertake such as, but not limited to: (i) advisory and review services; (ii) pre-investment or feasibility studies; (iii) design; (iv) construction supervision; (v) management and related services; and (vi) other technical services or special studies. (2016 revised IRR, Section 5[i])

Contract – Refers to the agreement entered into between the Procuring Entity and the Supplier or Manufacturer or Distributor or Service Provider for procurement of Goods and Services; Contractor for Procurement of Infrastructure Projects; or Consultant or Consulting Firm for Procurement of Consulting Services; as the case may be, as recorded in the Contract Form signed by the parties, including all attachments and appendices thereto and all documents incorporated by reference therein.

Contractor – is a natural or juridical entity whose proposal was accepted by the Procuring Entity and to whom the Contract to execute the Work was awarded. Contractor as used in these Bidding Documents may likewise refer to a supplier, distributor, manufacturer, or consultant.

CPI – Consumer Price Index.

DOLE – Department of Labor and Employment.

DTI – Department of Trade and Industry.

Foreign-funded Procurement or Foreign-Assisted Project –Refers to procurement whose funding source is from a foreign government, foreign or international financing institution as specified in the Treaty or International or Executive Agreement. (2016 revised IRR, Section 5[b]).

GFI – Government Financial Institution.

GOCC –Government-owned and/or –controlled corporation.

Goods – Refer to all items, supplies, materials and general support services, except Consulting Services and Infrastructure Projects, which may be needed in the transaction of public businesses or in the pursuit of any government undertaking, project or activity, whether in the nature of equipment, furniture, stationery, materials for construction, or personal property of any kind, including non-personal or contractual services such as the repair and maintenance of equipment and furniture, as well as trucking, hauling, janitorial, security, and related or analogous services, as well as procurement of materials and supplies provided by the Procuring Entity for such services. The term “related” or “analogous services” shall include, but is not limited to, lease or purchase of office space, media advertisements, health maintenance services, and other services essential to the operation of the Procuring Entity. (2016 revised IRR, Section 5[r])

GOP – Government of the Philippines.

Infrastructure Projects – Include the construction, improvement, rehabilitation, demolition, repair, restoration or maintenance of roads and bridges, railways, airports, seaports, communication facilities, civil works components of information technology projects, irrigation, flood control and drainage, water supply, sanitation, sewerage and solid waste management systems, shore protection, energy/power and electrification facilities, national buildings, school buildings, hospital buildings, and other related construction projects of the government. Also referred to as *civil works or works*. (2016 revised IRR, Section 5[u])

LGUs – Local Government Units.

NFCC – Net Financial Contracting Capacity.

NGA – National Government Agency.

PCAB – Philippine Contractors Accreditation Board.

PhilGEPS - Philippine Government Electronic Procurement System.

Procurement Project – refers to a specific or identified procurement covering goods, infrastructure project or consulting services. A Procurement Project shall be described, detailed, and scheduled in the Project Procurement Management Plan prepared by the agency which shall be consolidated in the procuring entity's Annual Procurement Plan. (GPPB Circular No. 06-2019 dated 17 July 2019)

PSA – Philippine Statistics Authority.

SEC – Securities and Exchange Commission.

SLCC – Single Largest Completed Contract.

UN – United Nations.

Section I. Invitation to Bid



Republic of the Philippines
DEPARTMENT OF AGRICULTURE
 Regional Field Office No. 1
 Aguila Road, Sevilla, City of San Fernando, La Union
 Telephone No. (072) 242 1045/1046



INVITATION TO BID FOR THE PROVISION OF LABOR, MATERIALS, EQUIPMENT RENTAL AND OTHER INCIDENTALS NEEDED FOR THE CONSTRUCTION OF PERIMETER FENCE WITH GATE, WAITING SHED AND GUARD HOUSE AT DA-ISREC, SAN JUAN, ILOCOS SUR

1. The Department of Agriculture - Regional Field Office 1 (DA-RFO 1), through the GAA FY 2025 intends to apply the sum of **Six Million Nine Hundred Ninety-Nine Thousand Nine Hundred Fifty-Six Pesos (PhP6,999,956.00)** being the Approved Budget for the Contract (ABC) to payment under the contract for the **PROVISION OF LABOR, MATERIALS, EQUIPMENT RENTAL AND OTHER INCIDENTALS NEEDED FOR THE CONSTRUCTION OF PERIMETER FENCE WITH GATE, WAITING SHED AND GUARD HOUSE AT DA-ISREC, SAN JUAN, ILOCOS SUR** with project identification number **DA-RFO 1-2025-INFRA-016**. Bids received in excess of the ABC shall be automatically rejected at bid opening.
2. The DA-RFO 1 now invites bids for the above procurement project with the following details and specifications:

| DETAILS AND SPECIFICATIONS | | |
|------------------------------------|--|-------------|
| Project Location: | DA-ISReC, San Juan, Ilocos Sur | |
| Project Description: | Construction of 450 Linear Meter Perimeter Fence: Installation of 1 unit sliding gate and construction of 1 unit waiting shed and guard house. | |
| Scope of work: | | |
| Description | Qty | Unit |
| I. Mobilization and Demobilization | 1.00 | l.s. |
| II. Construction Safety and Health | 1.00 | l.s. |
| III. Temporary Facility | 12.00 | sq.m. |
| IV. Project Sign Board and Permits | 1.00 | lot |
| V. Clearing and Grubbing | 477.47 | sq.m. |
| VI. Demolition Works | 1.00 | lot |
| VII. Earthworks | 178.00 | cu.m. |
| VIII. RSB Works | 9,266.14 | kgs |
| IX. Form Works | 356.01 | sq.m. |
| X. Concrete Works | 199.19 | cu.m. |
| XI. Masonry Works | 732.60 | sq.m. |
| XII. Steel Works | 1.00 | lot |
| XIII. Painting Works | 732.60 | sq.m. |
| XIV. Roofing Works | 1.00 | lot |
| XV. Electrical Works | 15.00 | outlets |
| XVI. Doors and Windows | 8.36 | sq.m. |

MINIMUM TECHNICAL PERSONNEL REQUIRED:

- 1 Field Engineer
- 1 Foreman
- 6 Skilled Laborers
- 12 Unskilled Laborers

MINIMUM EQUIPMENT REQUIRED:

- 1 Welding Machine
- 1 Set Hand Tools
- 1 Bagger Mixer

Completion of the Works is within **one hundred fifty-five (155) calendar days**. Bidders should have completed a contract similar to the Project. The description of an eligible bidder is contained in the Bidding Documents, particularly, in Section II. (Instructions to Bidders).

3. Bidding will be conducted through open competitive bidding procedures using a non-discretionary “pass/fail” criterion as specified in the Implementing Rules and Regulations (IRR) of Republic Act (RA) 9184.

Bidding is restricted to Filipino citizens/sole proprietorships, partnerships, or organizations with at least seventy-five percent (75%) interest or outstanding capital stock belonging to citizens of the Philippines.

4. Prospective bidders may obtain further information from and inspect the Bidding Documents at the address given below during **office hours at 8:00 AM to 5:00 PM, Monday to Friday**.

**Department of Agriculture - Regional Field Office 1
Aguila Rd., Sevilla, City of San Fernando, La Union**

5. A complete set of Bidding Documents may be acquired by interested Bidders from **January 13, 2025 to February 5, 2025** from the address given and websites below and upon payment of the applicable fee for the Bidding Documents, pursuant to the latest Guidelines issued by the GPPB, in the amount of **Php10,000.00**. The Procuring Entity shall allow the bidder to present its proof of payment for the fees in person, by facsimile, or through electronic means.
6. The **DA-RFO 1** will hold a Pre-Bid Conference on **24 January 2025, 9:00 AM** at DA-RFO 1, 5th Floor Conference Room, Aguila Road, Sevilla, City of San Fernando, La Union, which shall be open to prospective bidders.
7. Bids must be duly received by the BAC Secretariat through manual submission at the office address indicated above on or before **05 February 2025, 9:00 AM. Late bids shall not be accepted.**
8. All bids must be accompanied by a bid security in any of the acceptable forms and in the amount stated in **ITB** Clause 14.
9. **Bid opening** shall be on **05 February 2025, 9:00 AM** at DA-RFO 1, 5th Floor Conference Room, Aguila Road, Sevilla, City of San Fernando, La Union. Bids will be opened in the presence of the bidders or their authorized representatives.

10. **ADDITIONAL INSTRUCTIONS TO BIDDERS:**

- a. The bidders or their duly authorized representatives may attend the bid opening;
- b. In case a representative will be attending the Bid Opening, a Special Power of Attorney (SPA), Secretary's Certificate, Board Resolution or any other forms of authorization (notarized), as the case may be, together with the Company-issued Identification Card or any valid ID must be presented upon submission of the bid proposal at the BAC Secretariat. The name/title of the project must be indicated in the authorization or SPA.
- c. Each Bidder shall submit one copy of the first and second components of its Bid. Bidders shall submit their bids with proper index tabbing using the forms specified in the Bidding Documents in two (2) separate sealed bid envelopes, and which shall be submitted simultaneously;

The first component which is the Technical Eligibility requirements must be soft-bound, marked with the **name of the contract** and its **IB No., name and address of the bidder**, and enclosed in an envelope, sealed with signature and marked with the **name of the contract, name and address of the bidder**, addressed to the **BIDS AND AWARDS COMMITTEE (BAC) DA RFO-1 CITY OF SAN FERNANDO, LA UNION**, the **specific Identification No.** and the warning **"DO NOT OPEN BEFORE..."** the date and time for the bid opening.

The second component being the Financial requirements may be soft-bound/fastened in a folder, marked with the **name of the contract** and its **IB No., name and address of the bidder**, and enclosed in an envelope, sealed with signature and marked with the **name of the contract, name and address of the bidder**, addressed to the **BIDS AND AWARDS COMMITTEE (BAC) DA RFO-1 CITY OF SAN FERNANDO, LA UNION**, the **specific Identification No.** and the warning **"DO NOT OPEN BEFORE..."** the date and time for the bid opening.

The Technical and Financial Requirement each in separate envelopes, shall be enclosed in a mother envelope with the same sealing and markings.

Non-compliance with index tabbings shall not be a ground for outright disqualification or declaration of ineligibility. The improper index tabbings must be duly acknowledged by the bidder/representative and be subject to the bid evaluation and post-qualification of the Technical Working Group (TWG) as to their substance.

- d. All **documents** in the **Financial Requirements envelope** must be **duly signed and/or initialed**, as needed, by the bidder/authorized representative on **EACH AND EVERY PAGE** thereof.
11. The **DA-RFO 1** reserves the right to reject any and all bids, declare a failure of bidding, or not award the contract at any time prior to contract award in accordance with Sections 35.6 and Section 41 of the 2016 Revised IRR of RA No. 9184, without thereby incurring any liability to the affected bidder or bidders.

12. For further information, please refer to:

DENNIS I. TACTAC, ABE

Chairperson, Bids and Awards Committee

Department of Agriculture - Regional Field Office 1

Aguila Road, Sevilla, City of San Fernando, La Union

Tel. No.:(072) 242/1045-46, Ext. 07

E-mail add: bacsec@ilocos.da.gov.ph

13. For downloading of Bidding Documents, you may visit the following websites:

DA-RFO1 Website: <https://ilocos.da.gov.ph/>

PhilGEPS Website: <https://www.philgeps.gov.ph/>

January 10, 2025

Approved by:

(Sgd.) GILBERT D. RABARA, DVM

Vice-Chairperson, Bids and Awards Committee

Invitation to Bid Identification No. DA-RFO 1-2025-INFRA-016

Section II. Instructions to Bidders

1. Scope of Bid

The Procuring Entity, **Department of Agriculture - Regional Field Office 1 (DA-RFO 1)** invites Bids for the **PROVISION OF LABOR, MATERIALS, EQUIPMENT RENTAL AND OTHER INCIDENTALS NEEDED FOR THE CONSTRUCTION OF PERIMETER FENCE WITH GATE, WAITING SHED AND GUARD HOUSE AT DA-ISREC, SAN JUAN, ILOCOS SUR** with Project Identification Number **DA-RFO 1-2025-INFRA-016**.

The Procurement Project (referred to herein as “Project”) is for the construction of Works, as described in Section VI (Specifications).

2. Funding Information

2.1. The GOP through the source of funding as indicated below for **GAA FY 2025** in the amount of **Six Million Nine Hundred Ninety-Nine Thousand Nine Hundred Fifty-Six Pesos (PhP6,999,956.00)**.

3. Bidding Requirements

The Bidding for the Project shall be governed by all the provisions of RA No. 9184 and its 2016 revised IRR, including its Generic Procurement Manual and associated policies, rules and regulations as the primary source thereof, while the herein clauses shall serve as the secondary source thereof.

Any amendments made to the IRR and other GPPB issuances shall be applicable only to the ongoing posting, advertisement, or invitation to bid by the BAC through the issuance of a supplemental or bid bulletin.

The Bidder, by the act of submitting its Bid, shall be deemed to have inspected the site, determined the general characteristics of the contracted Works and the conditions for this Project, such as the location and the nature of the work; (b) climatic conditions; (c) transportation facilities; (c) nature and condition of the terrain, geological conditions at the site communication facilities, requirements, location and availability of construction aggregates and other materials, labor, water, electric power and access roads; and (d) other factors that may affect the cost, duration and execution or implementation of the contract, project, or work and examine all instructions, forms, terms, and project requirements in the Bidding Documents.

4. Corrupt, Fraudulent, Collusive, Coercive, and Obstructive Practices

The Procuring Entity, as well as the Bidders and Contractors, shall observe the highest standard of ethics during the procurement and execution of the contract. They or through an agent shall not engage in corrupt, fraudulent, collusive, coercive, and obstructive practices defined under Annex “I” of the 2016 revised IRR of RA No. 9184 or other integrity violations in competing for the Project.

5. Eligible Bidders

- 5.1. Only Bids of Bidders found to be legally, technically, and financially capable will be evaluated.
- 5.2. The Bidder must have an experience of having completed a Single Largest Completed Contract (SLCC) that is similar to this Project, equivalent to at least fifty percent (50%) of the ABC adjusted, if necessary, by the Bidder to current prices using the PSA's CPI, except under conditions provided for in Section 23.4.2.4 of the 2016 revised IRR of RA No. 9184.

A contract is considered to be "similar" to the contract to be bid if it has the major categories of work stated in the **BDS**.
- 5.3. For Foreign-funded Procurement, the Procuring Entity and the foreign government/foreign or international financing institution may agree on another track record requirement, as specified in the Bidding Document prepared for this purpose.
- 5.4. The Bidders shall comply with the eligibility criteria under Section 23.4.2 of the 2016 IRR of RA No. 9184.

6. Origin of Associated Goods

There is no restriction on the origin of Goods other than those prohibited by a decision of the UN Security Council taken under Chapter VII of the Charter of the UN.

7. Subcontracts

- 7.1. The Bidder may subcontract portions of the Project to the extent allowed by the Procuring Entity as stated herein, but in no case more than fifty percent (50%) of the Project.

The Procuring Entity has prescribed that subcontracting is not allowed:

8. Pre-Bid Conference

The Procuring Entity will hold a pre-bid conference for this Project on the specified date and time and either at its physical address, **5th Floor Conference Room, Aguila Road, Sevilla, City of San Fernando, La Union** indicated in paragraph 6 of the **IB**.

9. Clarification and Amendment of Bidding Documents

Prospective bidders may request for clarification on and/or interpretation of any part of the Bidding Documents. Such requests must be in writing and received by the Procuring Entity, either at its given address or through electronic mail indicated in the **IB**, at least ten (10) calendar days before the deadline set for the submission and receipt of Bids.

10. Documents Comprising the Bid: Eligibility and Technical Components

- 10.1. The first envelope shall contain the eligibility and technical documents of the Bid as specified in **Section IX. Checklist of Technical and Financial Documents**.
- 10.2. If the eligibility requirements or statements, the bids, and all other documents for submission to the BAC are in foreign language other than English, it must be accompanied by a translation in English, which shall be authenticated by the appropriate Philippine foreign service establishment, post, or the equivalent office having jurisdiction over the foreign bidder's affairs in the Philippines. For Contracting Parties to the Apostille Convention, only the translated documents shall be authenticated through an apostille pursuant to GPPB Resolution No. 13-2019 dated 23 May 2019. The English translation shall govern, for purposes of interpretation of the bid.
- 10.3. A valid PCAB License is required, and in case of joint ventures, a valid special PCAB License, and registration for the type and cost of the contract for this Project. Any additional type of Contractor license or permit shall be indicated in the **BDS**.
- 10.4. A List of Contractor's key personnel (e.g., Project Manager, Project Engineers, Materials Engineers, and Foremen) assigned to the contract to be bid, with their complete qualification and experience data shall be provided. These key personnel must meet the required minimum years of experience set in the **BDS**.
- 10.5. A List of Contractor's major equipment units, which are owned, leased, and/or under purchase agreements, supported by proof of ownership, certification of availability of equipment from the equipment lessor/vendor for the duration of the project, as the case may be, must meet the minimum requirements for the contract set in the **BDS**.

11. Documents Comprising the Bid: Financial Component

- 11.1. The second bid envelope shall contain the financial documents for the Bid as specified in **Section IX. Checklist of Technical and Financial Documents**.
- 11.2. Any bid exceeding the ABC indicated in paragraph 1 of the **IB** shall not be accepted.
- 11.3. For Foreign-funded procurement, a ceiling may be applied to bid prices provided the conditions are met under Section 31.2 of the 2016 revised IRR of RA No. 9184.

12. Alternative Bids

Bidders shall submit offers that comply with the requirements of the Bidding Documents, including the basic technical design as indicated in the drawings and specifications. Unless there is a value engineering clause in the **BDS**, alternative Bids shall not be accepted.

13. Bid Prices

All bid prices for the given scope of work in the Project as awarded shall be considered as fixed prices, and therefore not subject to price escalation during contract implementation, except under extraordinary circumstances as determined by the NEDA and approved by the GPPB pursuant to the revised Guidelines for Contract Price Escalation guidelines.

14. Bid and Payment Currencies

14.1. Bid prices may be quoted in the local currency or tradeable currency accepted by the BSP at the discretion of the Bidder. However, for purposes of bid evaluation, Bids denominated in foreign currencies shall be converted to Philippine currency based on the exchange rate as published in the BSP reference rate bulletin on the day of the bid opening.

14.2. *Payment of the contract price shall be made in:*

- a. Philippine Pesos.

15. Bid Security

15.1. The Bidder shall submit a Bid Securing Declaration or any form of Bid Security in the amount indicated in the **BDS**, which shall be not less than the percentage of the ABC in accordance with the schedule in the **BDS**.

15.2. The Bid and bid security shall be valid until **June 5, 2024**. Any bid not accompanied by an acceptable bid security shall be rejected by the Procuring Entity as non-responsive.

16. Sealing and Marking of Bids

Each Bidder shall submit one copy of the first and second components of its Bid.

The Procuring Entity may request additional hard copies and/or electronic copies of the Bid. However, failure of the Bidders to comply with the said request shall not be a ground for disqualification.

If the Procuring Entity allows the submission of bids through online submission to the given website or any other electronic means, the Bidder shall submit an electronic copy of its Bid, which must be digitally signed. An electronic copy that cannot be

opened or is corrupted shall be considered non-responsive and, thus, automatically disqualified.

17. Deadline for Submission of Bids

The Bidders shall submit on the specified date and time and either at its physical address or through online submission as indicated in paragraph 7 of the **IB**.

18. Opening and Preliminary Examination of Bids

18.1. The BAC shall open the Bids in public at the time, on the date, and at the place specified in paragraph 9 of the **IB**. The Bidders' representatives who are present shall sign a register evidencing their attendance. In case videoconferencing, webcasting or other similar technologies will be used, attendance of participants shall likewise be recorded by the BAC Secretariat.

In case the Bids cannot be opened as scheduled due to justifiable reasons, the rescheduling requirements under Section 29 of the 2016 revised IRR of RA No. 9184 shall prevail.

18.2. The preliminary examination of Bids shall be governed by Section 30 of the 2016 revised IRR of RA No. 9184.

19. Detailed Evaluation and Comparison of Bids

19.1. The Procuring Entity's BAC shall immediately conduct a detailed evaluation of all Bids rated "*passed*" using non-discretionary pass/fail criteria. The BAC shall consider the conditions in the evaluation of Bids under Section 32.2 of 2016 revised IRR of RA No. 9184.

19.2. If the Project allows partial bids, all Bids and combinations of Bids as indicated in the **BDS** shall be received by the same deadline and opened and evaluated simultaneously so as to determine the Bid or combination of Bids offering the lowest calculated cost to the Procuring Entity. Bid Security as required by **ITB** Clause 15 shall be submitted for each contract (lot) separately.

19.3. In all cases, the NFCC computation pursuant to Section 23.4.2.6 of the 2016 revised IRR of RA No. 9184 must be sufficient for the total of the ABCs for all the lots participated in by the prospective Bidder.

20. Post Qualification

Within a non-extendible period of five (5) calendar days from receipt by the Bidder of the notice from the BAC that it submitted the Lowest Calculated Bid, the Bidder shall submit its latest income and business tax returns filed and paid through the BIR Electronic Filing and Payment System (eFPS), and other appropriate licenses and permits required by law and stated in the **BDS**.

21. Signing of the Contract

The documents required in Section 37.2 of the 2016 revised IRR of RA No. 9184 shall form part of the Contract. Additional Contract documents are indicated in the **BDS**.

Section III. Bid Data Sheet

Bid Data Sheet

| ITB Clause | | | | | | | | | | | | | |
|-----------------|--|--------------------------|--------------------|---------------------|-----------------|---------|--------------------------|------------|---------|-------------------|-------|------------|---|
| 5.2 | For this purpose, contracts similar to the Project refer to contracts which have the same major categories of work, which shall be: CONSTRUCTION OF PERIMETER FENCE OR ANY VERTICAL STRUCTURE | | | | | | | | | | | | |
| 7.1 | N/A | | | | | | | | | | | | |
| 10.3 | N/A | | | | | | | | | | | | |
| 10.4 | The key personnel must meet the required minimum years of experience set below: <table border="1" style="margin-left: auto; margin-right: auto;"> <thead> <tr> <th style="text-align: center;">Key Personnel</th> <th style="text-align: center;">General Experience</th> <th style="text-align: center;">Relevant Experience</th> </tr> </thead> <tbody> <tr> <td style="text-align: center;">Field Engineer</td> <td style="text-align: center;">3 years</td> <td style="text-align: center;">Construction Supervision</td> </tr> <tr> <td style="text-align: center;">Foreman</td> <td style="text-align: center;">2 years</td> <td style="text-align: center;">Masonry/Carpentry</td> </tr> </tbody> </table> | Key Personnel | General Experience | Relevant Experience | Field Engineer | 3 years | Construction Supervision | Foreman | 2 years | Masonry/Carpentry | | | |
| Key Personnel | General Experience | Relevant Experience | | | | | | | | | | | |
| Field Engineer | 3 years | Construction Supervision | | | | | | | | | | | |
| Foreman | 2 years | Masonry/Carpentry | | | | | | | | | | | |
| 10.5 | The minimum major equipment requirements are the following: <table border="1" style="margin-left: auto; margin-right: auto;"> <thead> <tr> <th style="text-align: center;">Equipment</th> <th style="text-align: center;">Capacity</th> <th style="text-align: center;">No. of Units</th> </tr> </thead> <tbody> <tr> <td style="text-align: center;">Welding Machine</td> <td></td> <td style="text-align: center;">1</td> </tr> <tr> <td style="text-align: center;">Hand Tools</td> <td></td> <td style="text-align: center;">1 set</td> </tr> <tr> <td style="text-align: center;">Mixer</td> <td style="text-align: center;">one-bagger</td> <td style="text-align: center;">1</td> </tr> </tbody> </table> | Equipment | Capacity | No. of Units | Welding Machine | | 1 | Hand Tools | | 1 set | Mixer | one-bagger | 1 |
| Equipment | Capacity | No. of Units | | | | | | | | | | | |
| Welding Machine | | 1 | | | | | | | | | | | |
| Hand Tools | | 1 set | | | | | | | | | | | |
| Mixer | one-bagger | 1 | | | | | | | | | | | |
| 12 | N/A | | | | | | | | | | | | |
| 15.1 | The bid security shall be in the form of a Bid Securing Declaration or any of the following forms and amounts: <ul style="list-style-type: none"> a. The amount of not less than Php139,999.12 bid security is in cash, cashier's/manager's check, bank draft/guarantee or irrevocable letter of credit; b. The amount of not less than Php349,997.80 bid security is in Surety Bond. | | | | | | | | | | | | |
| 19.2 | Partial bidis not allowed. | | | | | | | | | | | | |
| 20 | Latest income and business tax returns filed and paid through the BIR Electronic Filing and Payment System (eFPS) and other appropriate licenses and permits required by law. | | | | | | | | | | | | |
| 21 | Additional contract documents relevant to the Project that may be required by existing laws and/or the Procuring Entity, such as construction schedule and S-curve, manpower schedule, construction methods, equipment utilization schedule, construction safety and health program approved by the DOLE, and other acceptable tools of project scheduling. | | | | | | | | | | | | |

Section IV. General Conditions of Contract

1. Scope of Contract

This Contract shall include all such items, although not specifically mentioned, that can be reasonably inferred as being required for its completion as if such items were expressly mentioned herein. All the provisions of RA No. 9184 and its 2016 revised IRR, including the Generic Procurement Manual, and associated issuances, constitute the primary source for the terms and conditions of the Contract, and thus, applicable in contract implementation. Herein clauses shall serve as the secondary source for the terms and conditions of the Contract.

This is without prejudice to Sections 74.1 and 74.2 of the 2016 revised IRR of RA No. 9184 allowing the GPPB to amend the IRR, which shall be applied to all procurement activities, the advertisement, posting, or invitation of which were issued after the effectivity of the said amendment.

2. Sectional Completion of Works

If sectional completion is specified in the **Special Conditions of Contract (SCC)**, references in the Conditions of Contract to the Works, the Completion Date, and the Intended Completion Date shall apply to any Section of the Works (other than references to the Completion Date and Intended Completion Date for the whole of the Works).

3. Possession of Site

3.1 The Procuring Entity shall give possession of all or parts of the Site to the Contractor based on the schedule of delivery indicated in the **SCC**, which corresponds to the execution of the Works. If the Contractor suffers delay or incurs cost from failure on the part of the Procuring Entity to give possession in accordance with the terms of this clause, the Procuring Entity's Representative shall give the Contractor a Contract Time Extension and certify such sum as fair to cover the cost incurred, which sum shall be paid by Procuring Entity.

3.2 If possession of a portion is not given by the above date, the Procuring Entity will be deemed to have delayed the start of the relevant activities. The resulting adjustments in contract time to address such delay may be addressed through contract extension provided under Annex "E" of the 2016 revised IRR of RA No. 9184.

4. The Contractor's Obligations

The Contractor shall employ the key personnel named in the Schedule of Key Personnel indicating their designation, in accordance with **ITB** Clause 10.3 and specified in the **BDS**, to carry out the supervision of the Works.

The Procuring Entity will approve any proposed replacement of key personnel only if their relevant qualifications and abilities are equal to or better than those of the personnel listed in the Schedule.

5. Performance Security

- 5.1. Within ten (10) calendar days from receipt of the Notice of Award from the Procuring Entity but in no case later than the signing of the contract by both parties, the successful Bidder shall furnish the performance security in any of the forms prescribed in Section 39 of the 2016 revised IRR.
- 5.2. The Contractor, by entering into the Contract with the Procuring Entity, acknowledges the right of the Procuring Entity to institute action pursuant to RA No. 3688 against any subcontractor be they an individual, firm, partnership, corporation, or association supplying the Contractor with labor, materials and/or equipment for the performance of this Contract.

6. Site Investigation Reports

The Contractor, in preparing the Bid, shall rely on any Site Investigation Reports referred to in the **SCC** supplemented by any information obtained by the Contractor.

7. Warranty

- 7.1. In case the Contractor fails to undertake the repair works under Section 62.2.2 of the 2016 revised IRR, the Procuring Entity shall forfeit its performance security, subject its property(ies) to attachment or garnishment proceedings, and perpetually disqualify it from participating in any public bidding. All payables of the GOP in his favor shall be offset to recover the costs.
- 7.2. The warranty against Structural Defects/Failures, except that occasioned-on force majeure, shall cover the period from the date of issuance of the Certificate of Final Acceptance by the Procuring Entity. Specific duration of the warranty is found in the **SCC**.

8. Liability of the Contractor

Subject to additional provisions, if any, set forth in the **SCC**, the Contractor's liability under this Contract shall be as provided by the laws of the Republic of the Philippines.

If the Contractor is a joint venture, all partners to the joint venture shall be jointly and severally liable to the Procuring Entity.

9. Termination for Other Causes

Contract termination shall be initiated in case it is determined *prima facie* by the Procuring Entity that the Contractor has engaged, before, or during the implementation of the contract, in unlawful deeds and behaviors relative to contract acquisition and implementation, such as, but not limited to corrupt, fraudulent, collusive, coercive, and obstructive practices as stated in **ITB** Clause 4.

10. Dayworks

Subject to the guidelines on Variation Order in Annex “E” of the 2016 revised IRR of RA No. 9184, and if applicable as indicated in the **SCC**, the Dayworks rates in the Contractor’s Bid shall be used for small additional amounts of work only when the Procuring Entity’s Representative has given written instructions in advance for additional work to be paid for in that way.

11. Program of Work

11.1. The Contractor shall submit to the Procuring Entity’s Representative for approval the said Program of Work showing the general methods, arrangements, order, and timing for all the activities in the Works. The submissions of the Program of Work are indicated in the **SCC**.

11.2. The Contractor shall submit to the Procuring Entity’s Representative for approval an updated Program of Work at intervals no longer than the period stated in the **SCC**. If the Contractor does not submit an updated Program of Work within this period, the Procuring Entity’s Representative may withhold the amount stated in the **SCC** from the next payment certificate and continue to withhold this amount until the next payment after the date on which the overdue Program of Work has been submitted.

12. Instructions, Inspections and Audits

The Contractor shall permit the GOP or the Procuring Entity to inspect the Contractor’s accounts and records relating to the performance of the Contractor and to have them audited by auditors of the GOP or the Procuring Entity, as may be required.

13. Advance Payment

The Procuring Entity shall, upon a written request of the Contractor which shall be submitted as a Contract document, make an advance payment to the Contractor in an amount not exceeding fifteen percent (15%) of the total contract price, to be made in lump sum, or at the most two installments according to a schedule specified in the **SCC**, subject to the requirements in Annex “E” of the 2016 revised IRR of RA No. 9184.

14. Progress Payments

The Contractor may submit a request for payment for Work accomplished. Such requests for payment shall be verified and certified by the Procuring Entity’s Representative/Project Engineer. Except as otherwise stipulated in the **SCC**, materials and equipment delivered on the site but not completely put in place shall not be included for payment.

15. Operating and Maintenance Manuals

- 15.1. If required, the Contractor will provide “as built” Drawings and/or operating and maintenance manuals as specified in the **SCC**.
- 15.2. If the Contractor does not provide the Drawings and/or manuals by the dates stated above, or they do not receive the Procuring Entity’s Representative’s approval, the Procuring Entity’s Representative may withhold the amount stated in the **SCC** from payments due to the Contractor.

Section V. Special Conditions of Contract

Special Conditions of Contract

| GCC Clause | |
|------------|--|
| 2 | N/A |
| 4.1 | Schedule of construction in full shall start within 7 calendar days from receipt of the Notice to Proceed |
| 6 | N/A |
| 7.2 | [In case of semi-permanent structures, such as buildings of types 1, 2, and 3 as classified under the National Building Code of the Philippines, concrete/asphalt roads, concrete river control, drainage, irrigation lined canals, river landing, deep wells, rock causeway, pedestrian overpass, and other similar semi-permanent structures:] Five (5) years. |
| 10 | a. Dayworks are applicable at the rate shown in the Contractor's original Bid. |
| 11.1 | The Contractor shall submit the Program of Work (PERT-CPM, Construction Schedule, S-Curve and Construction Methods) to the Procuring Entity's Representative within 10 calendar days of delivery of the Notice of Award. |
| 11.2 | The amount to be withheld for late submission of an updated Program of Work is 10% of the 15% Advance Payment. |
| 13 | The amount of the advance payment is 15% of the Contract Price. |
| 14 | Materials and equipment delivered on the site but not completely put in place (Actual Accomplishment) shall not be included for payment. |
| 15.1 | The "as built" Drawings and/or operating and maintenance manuals shall be required prior to the final payment. |
| 15.2 | The amount to be withheld for failing to produce "as built" drawings and/or operating and maintenance manuals by the date required is 10% of the final billing. |

Section VI. Specifications

Section VII. Drawings

[Insert here a list of Drawings. The actual Drawings, including site plans, should be attached to this section, or annexed in a separate folder.]

Section VIII. Bill of Quantities

Section IX. Checklist of Technical and Financial Documents

Checklist of Technical and Financial Documents

I. TECHNICAL COMPONENT ENVELOPE

Class “A” Documents

Legal Documents

- (a) Valid PhilGEPS Registration Certificate (Platinum Membership) (all pages) in accordance with Section 8.5.2 of the IRR;

Technical Documents

- (b) Statement of the prospective bidder of all its ongoing government and private contracts, including contracts awarded but not yet started, if any, whether similar or not similar in nature and complexity to the contract to be bid; **and**
- (c) Statement of the bidder’s Single Largest Completed Contract (SLCC) similar to the contract to be bid, except under conditions provided under the rules; **and**
- (d) Special PCAB License in case of Joint Ventures; **and** registration for the type and cost of the contract to be bid; **and**
- (e) Original copy of Bid Security. If in the form of a Surety Bond, submit also a certification issued by the Insurance Commission; **or**
Original copy of Notarized Bid Securing Declaration; **and**
- (f) Project Requirements, which shall include the following:
 - a. Organizational chart for the contract to be bid;
 - b. List of contractor’s key personnel (*e.g.*, Project Manager, Project Engineers, Materials Engineers, and Foremen), to be assigned to the contract to be bid, with their complete qualification and experience data;
 - c. List of contractor’s major equipment units, which are owned, leased, and/or under purchase agreements, supported by proof of ownership or certification of availability of equipment from the equipment lessor/vendor for the duration of the project, as the case may be; **and**
- (g) Original duly signed Omnibus Sworn Statement (OSS); **and** if applicable, Original Notarized Secretary’s Certificate in case of a corporation, partnership, or cooperative; or Original Special Power of Attorney of all members of the joint venture giving full power and authority to its officer to sign the OSS and do acts to represent the Bidder.

Financial Documents

- (h) The prospective bidder’s computation of Net Financial Contracting Capacity (NFCC).

Class “B” Documents

- (i) If applicable, duly signed joint venture agreement (JVA) in accordance with RA No. 4566 and its IRR in case the joint venture is already in existence; **or**
duly notarized statements from all the potential joint venture partners stating

that they will enter into and abide by the provisions of the JVA in the instance that the bid is successful.

II. FINANCIAL COMPONENT ENVELOPE

- (j) Original of duly signed and accomplished Financial Bid Form; **and**

Other documentary requirements under RA No. 9184

- (k) Original of duly signed Bid Prices in the Bill of Quantities; **and**
- (l) Duly accomplished Detailed Estimates Form, including a summary sheet indicating the unit prices of construction materials, labor rates, and equipment rentals used in coming up with the Bid; **and**
- (m) Cash Flow by Quarter.



BILL OF QUANTITIES

PROJECT NAME: CONSTRUCTION OF PERIMETER FENCE WITH GATE, WAITING SHED

PROJECT LOCATION: SINAIT NATIONAL HIGH SCHOOL SINAIT, ILOCOS SUR
AND GUARD HOUSE

PROJECT DESCRIPTION: Construction of 450 Linear Meter Perimeter Fence;
Installation of 1 unit Sliding Gate, and
Construction of 1 unit Waiting Shed and Guard house.

| ITEM NO. | DESCRIPTION | UNIT | QUANTITY | UNIT PRICE | AMOUNT |
|---------------------|---------------------------------|---------|----------|------------|--------|
| I | MOBILIZATION AND DEMOBILIZATION | l.s | 1.00 | | |
| II | CONSTRUCTION SAFETY AND HEALTH | l.s | 1.00 | | |
| III | TEMPORARY FACILITY | sq.m | 12.00 | | |
| IV | PROJECT SIGN BOARD AND PERMITS | lot | 1.00 | | |
| V | CLEARING AND GRUBBING | sq.m | 477.47 | | |
| VI | DEMOLITION WORKS | lot | 1.00 | | |
| VII | EARTHWORKS | cu.m | 178.00 | | |
| VIII | RSB WORKS | kgs | 9,266.14 | | |
| IX | FORM WORKS | sq.m | 356.01 | | |
| X | CONCRETE WORKS | cu.m | 199.19 | | |
| XI | MASONRY WORKS | sq.m | 732.60 | | |
| XII | STEEL WORKS | lot | 1.00 | | |
| XIII | PAINTING WORKS | sq.m | 732.60 | | |
| XIV | ROOFING WORKS | lot | 1.00 | | |
| XV | ELECTRICAL WORKS | outlets | 15.00 | | |
| XVI | DOORS & WINDOWS | sq.m | 10.86 | | |
| GRAND TOTAL: | | | | | |

NUMBER OF DAYS TO COMPLETE THE PROJECT: 155 Calendar Days

TOTAL AMOUNT OF BID (in words and figures): _____

Name in Print Company/Office/Firm

Full Name of Bidder/Authorize Representative

Address: _____

By: _____
Signature Over Printed Name

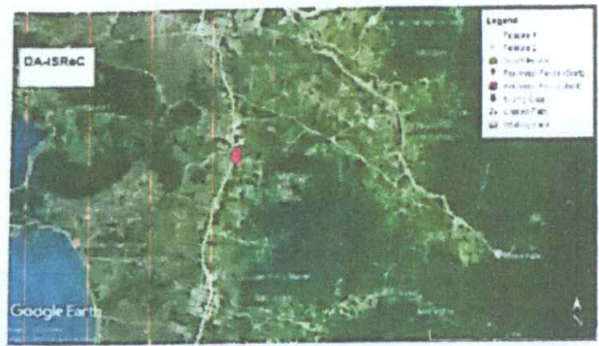

VICINITY MAP
SCALE NTS



DEVELOPMENT PLAN
SCALE NTS

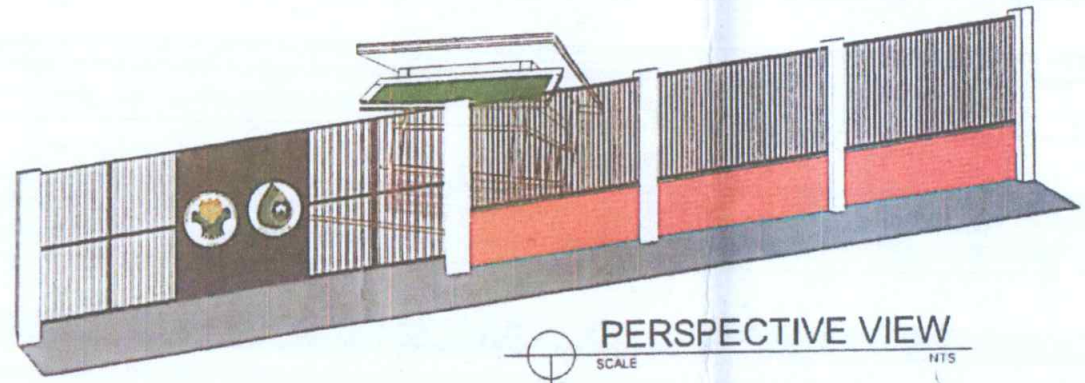
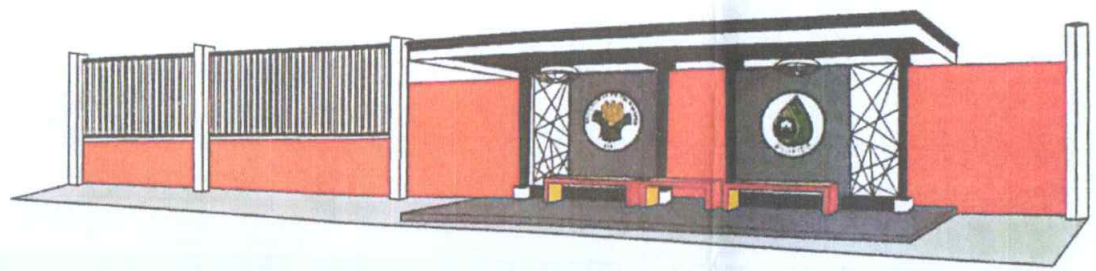

PERSPECTIVE VIEW
SCALE NTS



PREPARED FROM THE OFFICE OF THE
DEPARTMENT OF AGRICULTURE
 REGIONAL FIELD OFFICE I
 REGIONAL OFFICE, SAN FERNANDO CITY, LA UNION
 REGIONAL AGRICULTURAL ENGINEERING DIVISION

PROJECT TITLE
CONSTRUCTION OF PERIMETER FENCE WITH GATE, WAITING SHED AND GUARDHOUSE

PREPARED BY
EDEN RUTH S. INES, ABE
 TECHNICAL STAFF

CHECKED & REVIEWED BY
MARK HADJI G. PASTOR, ABE
 CHIEF

RECOMMENDING APPROVAL
DENNIS I. TACTAC, ABE
 BY THE OPERATIONS

APPROVED
JOHN B. PASCUAL, DVM
 DEPARTMENT OF AGRICULTURE

| SHEET CONTENTS | SHEET NO. |
|----------------|-----------|
| AS SHOWN | 1 |
| | 7 |

RD-4023-982 Rev. 01, 08/10/09

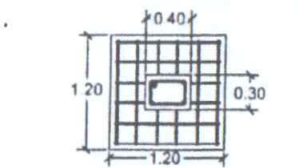

COLUMN FOOTING DETAILS

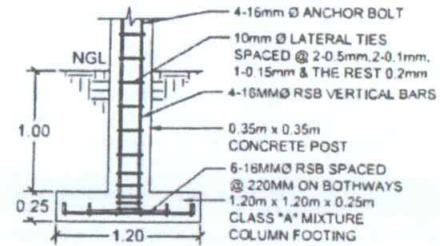

COLUMN DETAILS

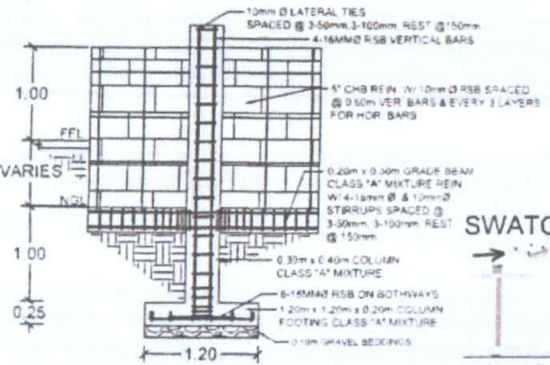

FENCE DETAILS

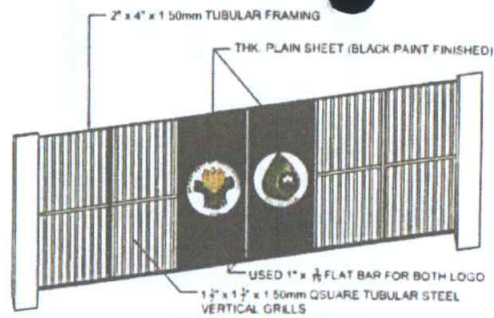

SLIDING GATE DETAILS

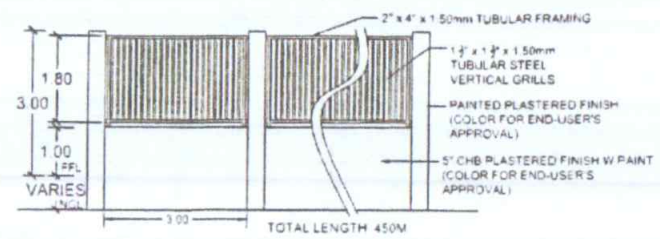

REAR VIEW

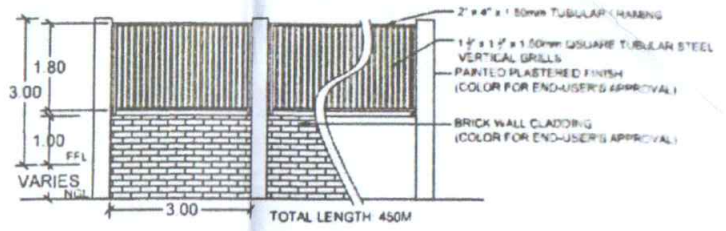

FRONT VIEW

BOOM GATE DESIGN

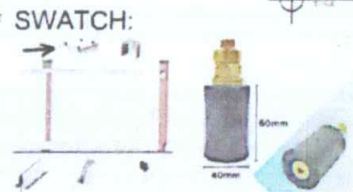
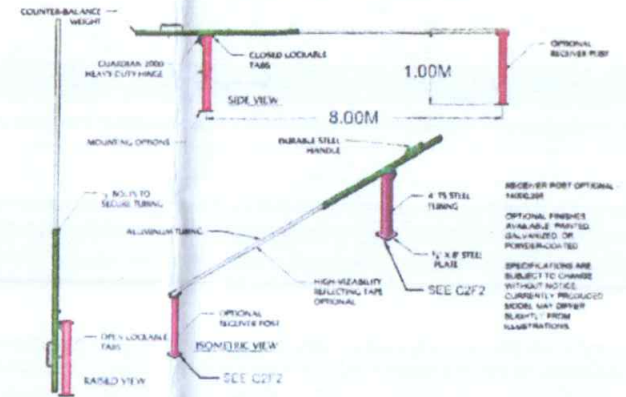

SCHEDULE OF FOOTING

| FOOTING MARK | FOOTING DIMENSIONS | | | | REINFORCEMENT | | REMARKS |
|--------------|--------------------|------------|------------------|--------------|------------------------|------------------------|----------|
| | Length (mm) | Width (mm) | Thickness T (mm) | Depth D (mm) | BAR, X | BAR, Y | |
| F1 | 120 | 120 | 25 | 130 | 6 @ 16mm \varnothing | 6 @ 16mm \varnothing | ISOLATED |

SCHEDULE OF COLUMNS

| LEVEL | C1 |
|-----------------------|--|
| GF TO TOP | |
| SIZE OF MAIN BAR TIES | 300x400 4-16mm \varnothing 10mm \varnothing - 3 @ 50 3 @ 100 REST 150mm |
| FDN TO GF | |
| SIZE OF MAIN BAR TIES | 300x400 4-16mm \varnothing 10mm \varnothing - 3 @ 50 3 @ 100 REST 150mm |

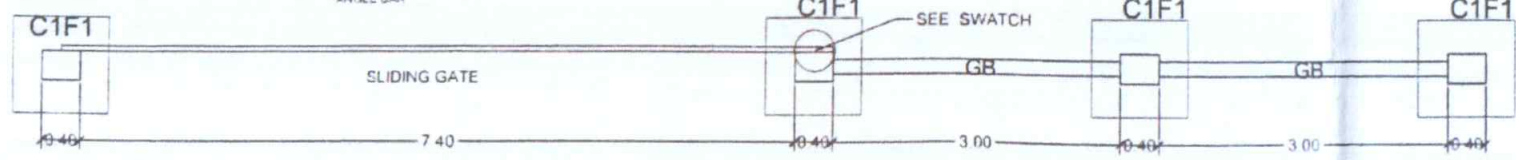

FOUNDATION DETAILS



PREPARED FROM THE OFFICE OF THE
 DEPARTMENT OF AGRICULTURE
 REGIONAL FIELD OFFICE
 AGUILAR ROAD, SYRIA, SANITARIANO CITY, LAOAG
 REGIONAL AGRICULTURAL ENGINEERING DIVISION

PROJECT TITLE:
 CONSTRUCTION OF PERIMETER FENCE WITH GATE, WAITING SHED AND GUARDHOUSE

PREPARED BY:
 EDEN RUTH S. INES, ABE
 TECHNICAL STAFF

CHECKED & REVIEWED BY:
 MARK HARRY A. PASTOR, ABE
 CHIEF ENGINEER

RECOMMENDING APPROVAL:
 DENNIS L. TACTAL, ABE
 REGIONAL SUPERVISOR

APPROVED:
 JOHN B. PASCUAL, DVM
 REGIONAL EXECUTIVE DIRECTOR

SHEET CONTENTS:
 AS SHOWN
 SHEET NO.
 2
 7

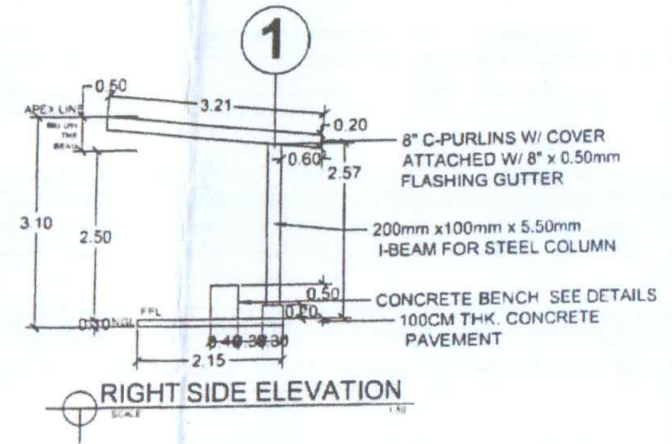
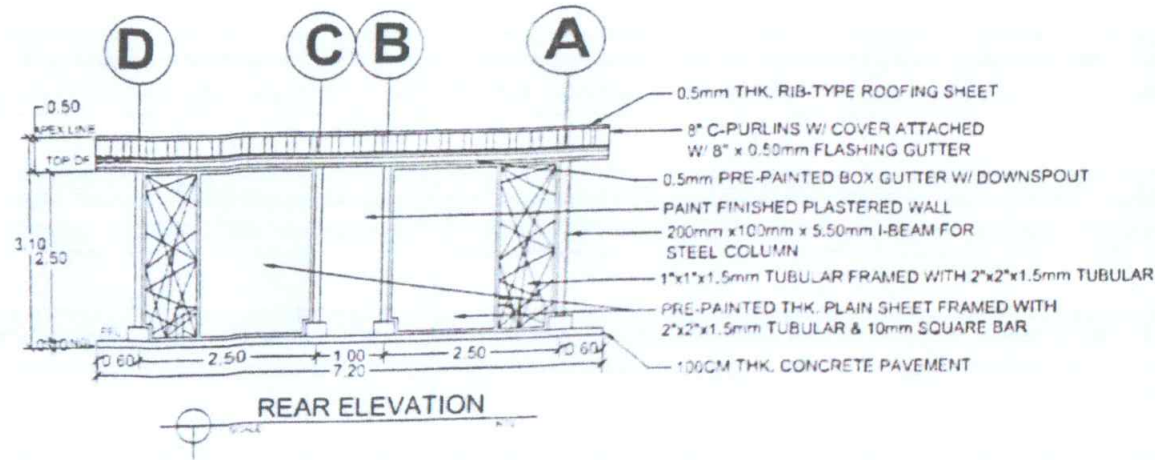
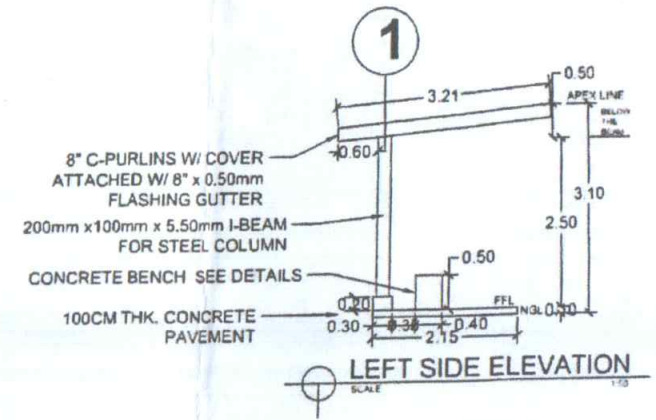
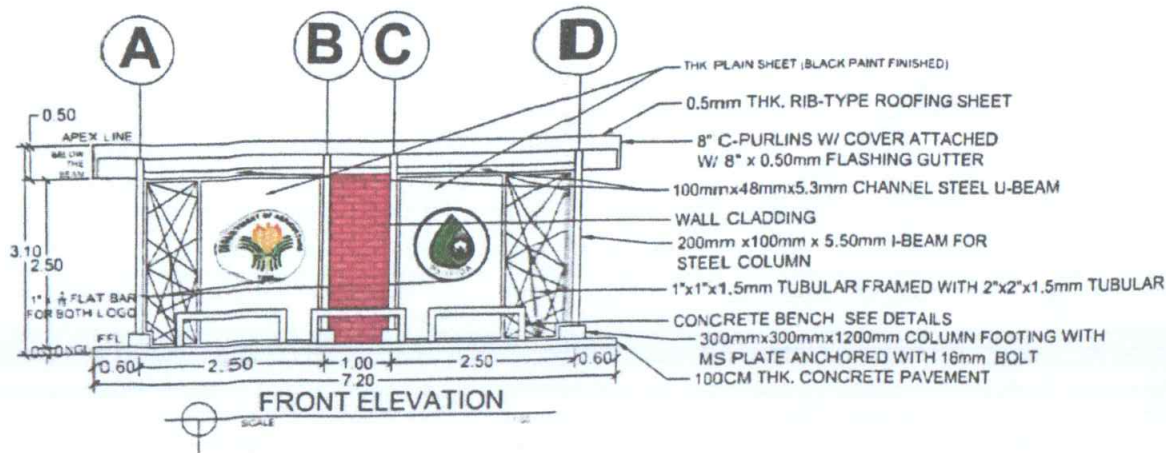

| | | | | | | | | |
|--|--|---|--|---|---|---|----------------------------|---------------------|
| | PREPARED FROM THE OFFICE OF THE DEPARTMENT OF AGRICULTURE REGIONAL FIELD OFFICE 1 AGUILA PRADO AVENUE, SAN FERDINAND CITY, LA UNION REGIONAL AGRICULTURAL ENGINEERING DIVISION | PROJECT TITLE CONSTRUCTION OF PERIMETER FENCE WITH GATE, WAITING SHED AND GUARDHOUSE | PREPARED BY EDEN RUTH S. INES, ABE TECHNICAL STAFF | CHECKED & REVIEWED BY MARK HARM G. PASTOR, ABE CHIEF BLDG | RECOMMENDING APPROVAL BENNIS L. TACTAC, ABE BLDG SUPERVISOR | APPROVED JOHN B. PASCUAL, DVM REGIONAL EXECUTIVE DIRECTOR | SHEET CONTENTS AS SHOWN | SHEET NO. 3 7 |
| | PLANNING DIVISION | | | | | | | |

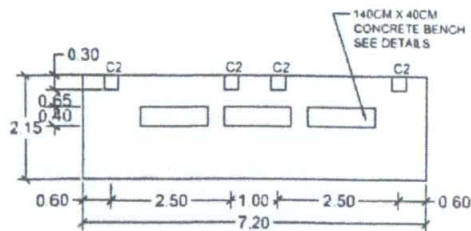

FLOOR PLAN

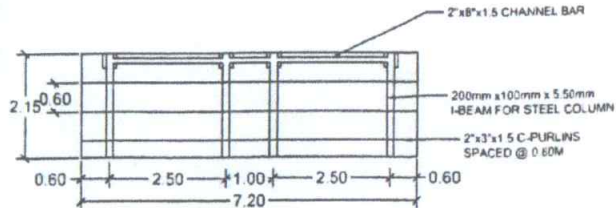

TRUSSES PLAN

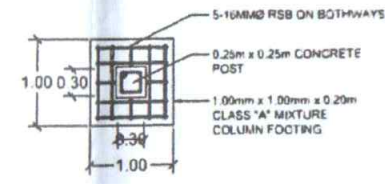

COLUMN FOOTING DETAILS, C2

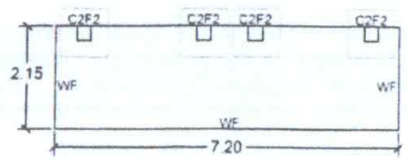

FOUNDATION PLAN

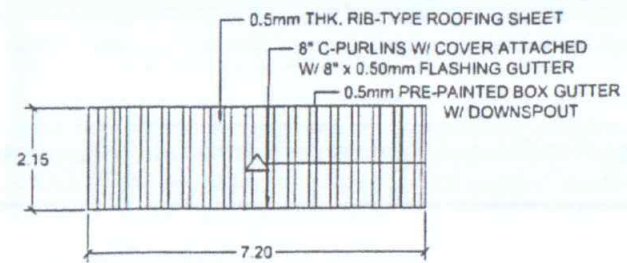

ROOF PLAN

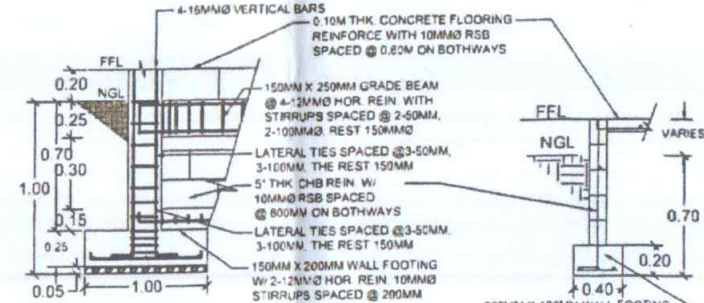

COLUMN DETAILS, C2

WALL FOOTING DETAILS

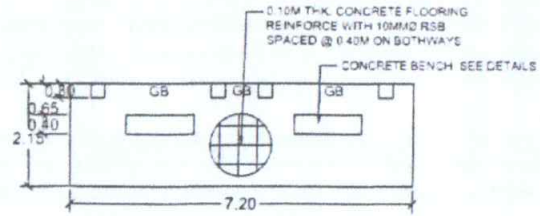

FLOOR FRAMING PLAN

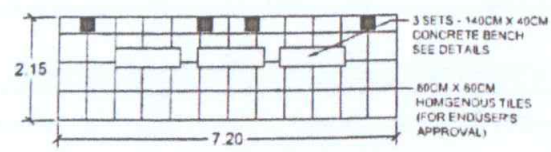

TILE PLAN

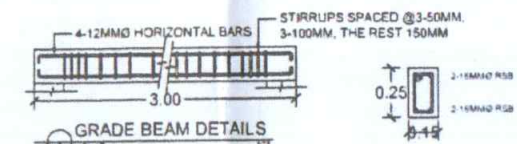

GRADE BEAM DETAILS

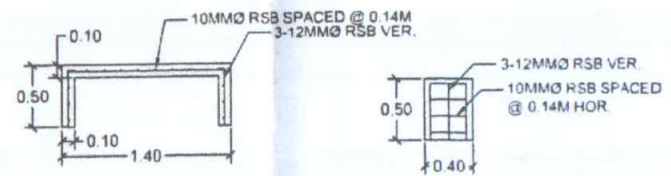

CONCRETE BENCH DETAILS



PREPARED FROM THE OFFICE OF THE
 DEPARTMENT OF THE PHILIPPINES
 DEPARTMENT OF AGRICULTURE
 REGIONAL FIELD OFFICE 1
 SAGALA ROAD, SERRILLA, SAN FERNANDO CITY, LA OROAN
 REGIONAL AGRICULTURAL ENGINEERING DIVISION

PROJECT TITLE
 CONSTRUCTION OF
 PERIMETER FENCE WITH
 GATE, WAITING SHED AND
 GUARDHOUSE

PREPARED BY
 EDEN RUTH S. INES, ABE
 TELEPHONE STAFF

CHECKED & REVIEWED BY
 MARK HARDY G. PASTOR, ABE
 CHIEF ASST

RECOMMENDING APPROVAL
 DENNIS T. TACTAL, ABE
 RTO FOR OPERATIONS

APPROVED
 JOHN B. PASCUAL, DVM
 ASL REGIONAL EXECUTIVE DIRECTOR

| SHEET CONTENTS | SHEET NO. |
|----------------|-----------|
| AS SHOWN | 4 |
| | 7 |

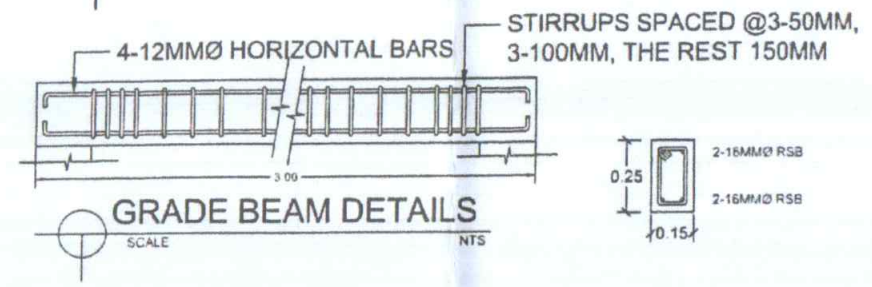
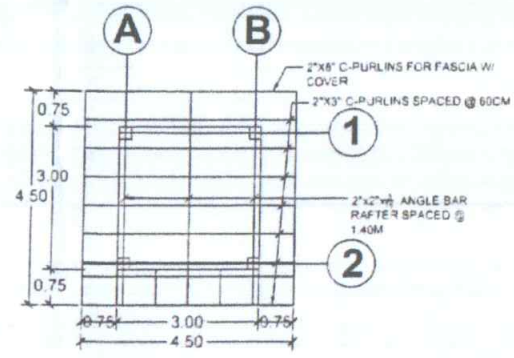
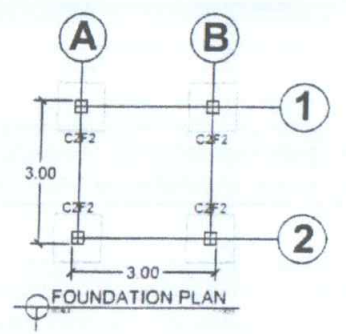
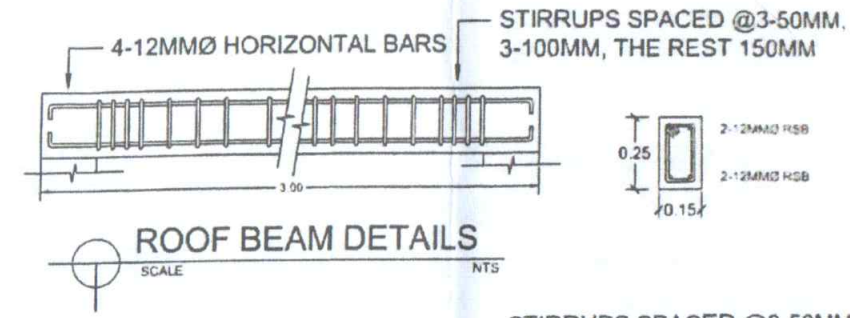
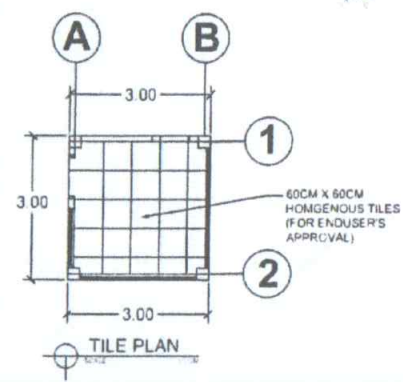
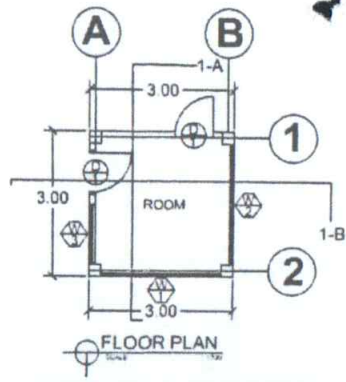

| DOORS AND WINDOWS SCHEDULE | | |
|----------------------------|-------|--------|
| ITEM | WIDTH | HEIGHT |
| D1 | 80CM | 210CM |
| W1 | 250CM | 100CM |
| W2 | 250CM | 100CM |
| W3 | 124CM | 100CM |

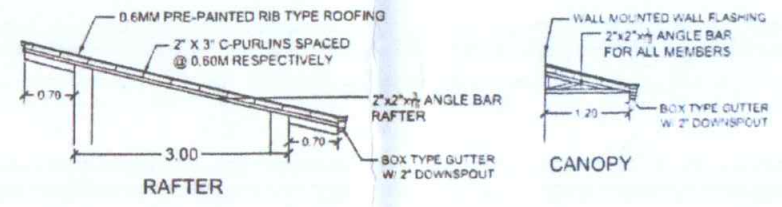
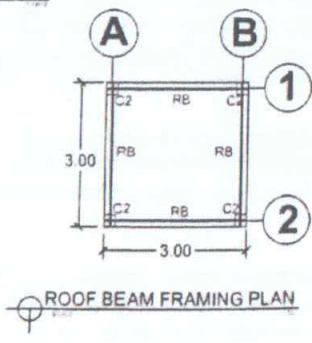
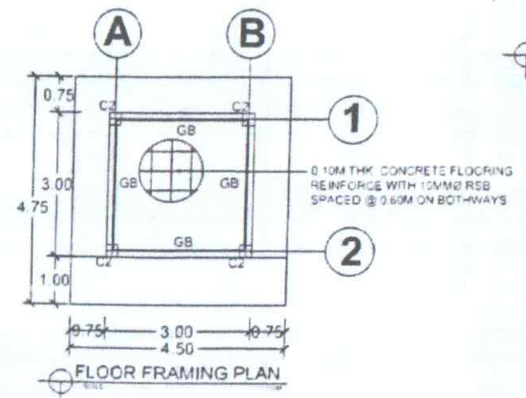

| | | | | | | | | |
|---|--|--|--|---|---|---|-------------------------------------|------------------------------|
| <p>DEPARTMENT OF AGRICULTURE 1998</p> | <p>PREPARED FROM THE OFFICE OF THE REPUBLIC OF THE PHILIPPINES DEPARTMENT OF AGRICULTURE REGIONAL FIELD OFFICE 1 MOGALWANG, NEW J.A. SAN FERNANDO CITY, LAUNOON REGIONAL AGRICULTURAL ENGINEERING DIVISION</p> | <p>PROJECT TITLE: CONSTRUCTION OF PERIMETER FENCE WITH GATE, WAITING SHED AND GUARDHOUSE</p> | <p>PREPARED BY: EDEN RUTH S. INES, ABE</p> | <p>CHECKED & REVIEWED BY: MARK HARRY V. PASTOR, ABE</p> | <p>RECOMMENDING APPROVAL: DENNIS I. TACTAC, ABE</p> | <p>APPROVED: JOHN D. PASCUAL, DVM</p> | <p>SHEET CONTENTS: AS SHOWN</p> | <p>SHEET NO. 5 7</p> |
| | <p>LOCATION: DA ORAC, SAN JUAN TRADING SUR</p> | <p>TECHNICAL STAFF</p> | <p>ENGINEER</p> | <p>BYD FOR OPERATIONS</p> | <p>DIR REGIONAL EXECUTIVE DIRECTOR</p> | | | |

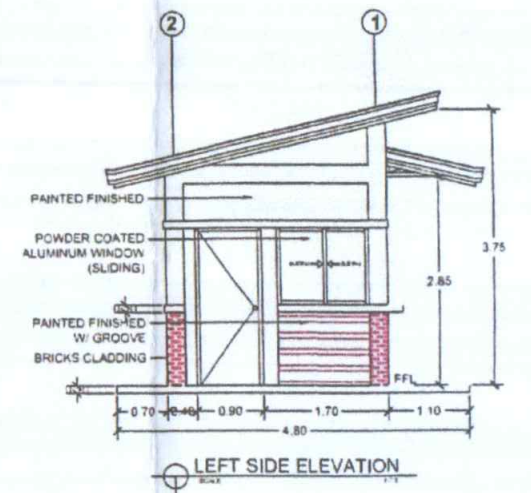
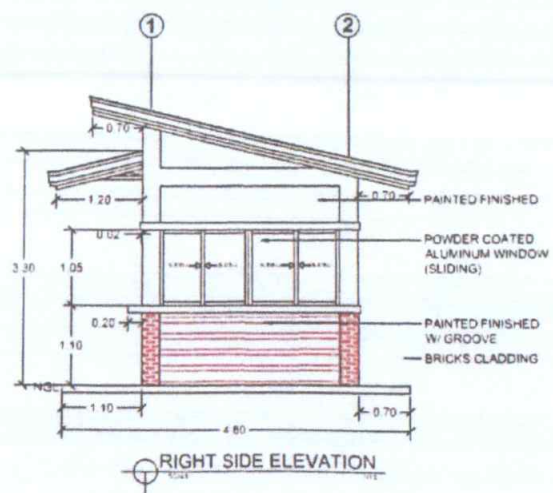
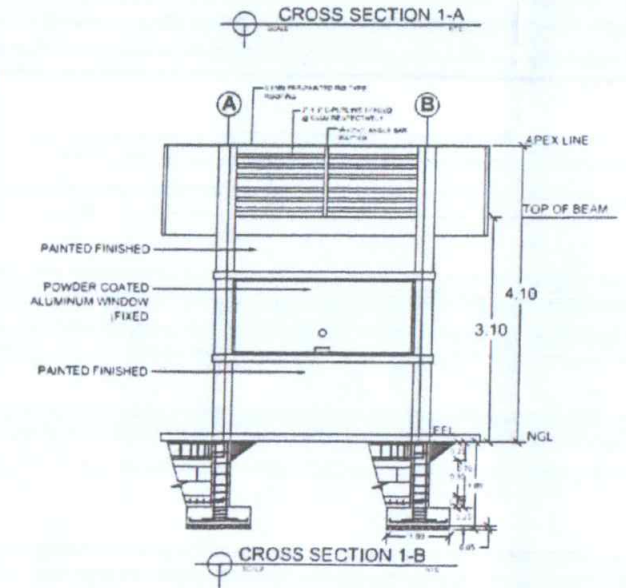
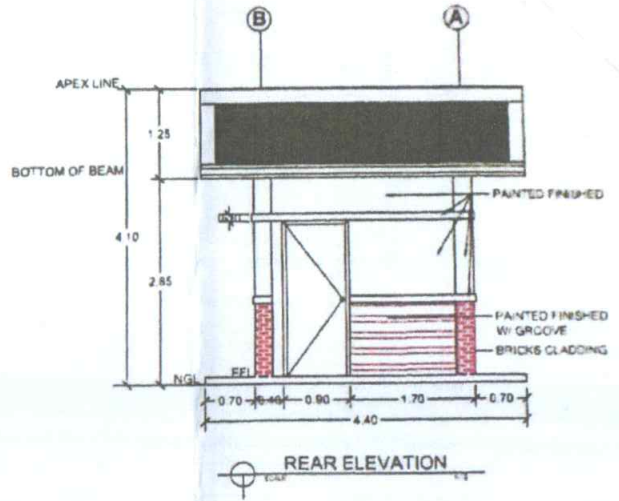
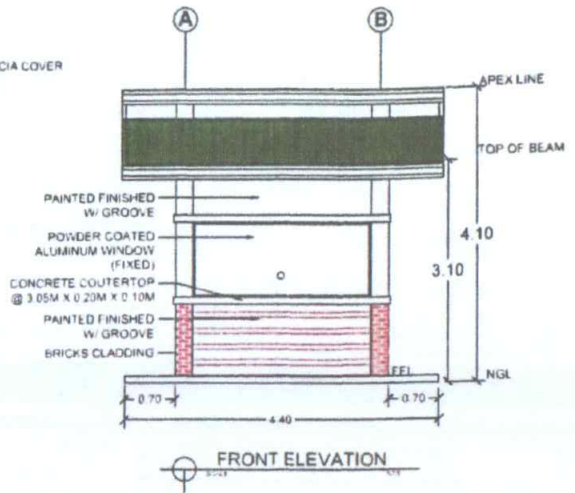
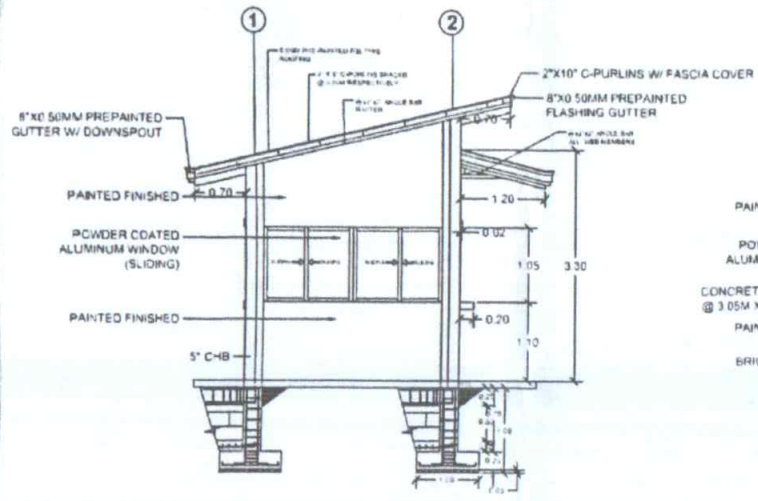

| | | | | | | | | |
|--|--|--|---|--|---|---|----------------|-----------|
| | PREPARED FROM THE OFFICE OF THE | PROJECT TITLE | PREPARED BY | CHECKED & REVIEWED BY | RECOMMENDING APPROVAL | APPROVED | SHEET CONTENTS | SHEET No. |
| | REPUBLIC OF THE PHILIPPINES DEPARTMENT OF AGRICULTURE REGIONAL FIELD OFFICE 1 MARILA ROAD, SEVILLA, SAN FERRANDO CITY, LA RIZON REGIONAL AGRICULTURAL ENGINEERING DIVISION | CONSTRUCTION OF PERIMETER FENCE WITH GATE, WAITING SHED AND GUARDHOUSE | EDEN RUTH S. INES, ABE TECHNICAL STAFF | MARK HARBY C. PASTOR, ABE CHIEF, RACD | DENNIS I. TACTAL, ABE WFO FOR OPERATIONS | JOHN B. PASCUAL, DVM REGIONAL EXECUTIVE DIRECTOR | AS SHOWN | 6 7 |

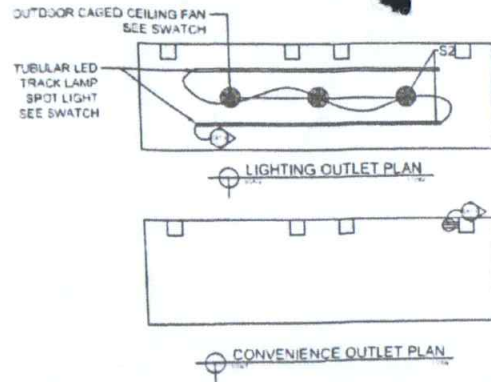

SWITCH

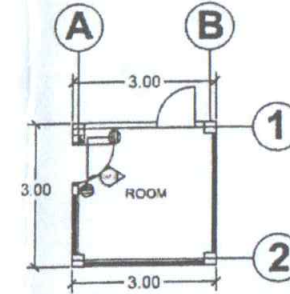
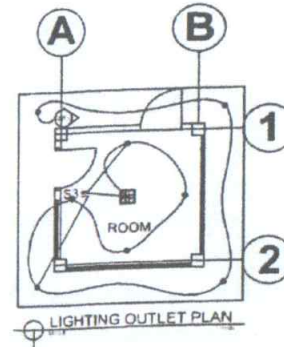

LEGEND:

| SYMBOL | DESCRIPTION |
|--------|---------------------------|
| | CONVENIENCE OUTLET |
| | PANEL BOARD |
| | CIRCUIT HOMERUN |
| | POWER CIRCUIT |
| | KILOWATT METER |
| | CIRCUIT BREAKER |
| | LED TRACK LAMP SPOT LIGHT |
| | OUTDOOR CAGED CEILING FAN |
| | 12" X 12" EXHAUST FAN |
| | OUTDOOR LED |

LOAD SCHEDULE & COMPUTATION FOR WAITING SHED

| CIRCUIT NO | DESCRIPTION | QTY | WATTS | VOLTAGE | AMPERE | CIRCUIT BREAKER | SIZE OF WIRE | CONDUIT |
|------------|--------------------|-----|-------|---------|--------|-----------------|--------------|---------|
| 1 | LIGHTING OUTLET | 4 | 430 | 230 | 1.74 | 15 AT | 2-2.0mm THW2 | 20mm Ø |
| 2 | CONVENIENCE OUTLET | 1 | 350 | 230 | 1.56 | 20 AT | 2-3.5mm THW2 | 25mm Ø |
| | TOTAL | | 780 | | 3.30 | | | |

LOAD SCHEDULE & COMPUTATION FOR GUARD HOUSE

| CIRCUIT NO | DESCRIPTION | QTY | WATTS | VOLTAGE | AMPERE | CIRCUIT BREAKER | SIZE OF WIRE | CONDUIT |
|------------|--------------------|-----|-------|---------|--------|-----------------|--------------|---------|
| 1 | LIGHTING OUTLET | 8 | 800 | 230 | 3.48 | 15 AT | 2-2.0mm THW2 | 20mm Ø |
| 2 | CONVENIENCE OUTLET | 2 | 720 | 230 | 3.13 | 20 AT | 2-3.5mm THW2 | 25mm Ø |
| | TOTAL | | 1520 | | 6.61 | | | |

USE OF FEEDER CONDUCTOR AND PROTECTION

CONDUCTOR
TOTAL = (3.30)(80%)
= 2.64 AMP

SIZE OF FEEDER PROTECTION

USE 2-5.5mm² THWN COPPER WIRE IN 25mm Ø RSC PIPE
MAIN PROTECTION USE 2P, 20AT, 240V, 60Hz CB

GENERAL ELECTRICAL NOTES

- THE ELECTRICAL SERVICE POWER IS 1-PHASE, 2-WIRE, 230 V AC, 60 HZ. ALL ELECTRICAL WORKS SHALL COMPLY IN ACCORDANCE WITH THESE PLANS AND SPECIFICATIONS, THE APPLICABLE PROVISIONS OF THE LATEST EDITION OF THE PHILIPPINE ELECTRICAL CODE (PEC), THE RULES AND REGULATION OF THE LOCAL ENFORCING AUTHORITY AND THE REQUIREMENTS OF THE LOCAL POWER COMPANY. THE ELECTRICAL WORKS SHALL BE DONE UNDER THE IMMEDIATE SUPERVISION OF A D-LY REGISTERED ELECTRICAL ENGINEER.
- THE ELECTRICAL SERVICE POWER IS 1-PHASE, 2-WIRE, 230 V AC, 60 HZ.
- WIRING METHOD SHALL BE AS FOLLOWS:
A. FEEDERS AND RISERS - INTERMEDIATE METALLIC CONDUIT
B. LIGHTING POWER RECEPTACLE - POLYVINYL CHLORIDE CONDUIT SCH. 40 - BRANCH CWT, & AUXILIARY.
- ALL MATERIALS TO BE USED SHALL BE BRAND NEW AND APPROVED TYPE FOR THE PARTICULAR LOCATION AND PURPOSE OF USAGE.
- ALL OUTLET BOXES SHALL BE GALVANIZED GAGE NO. 16 DEEP TYPE WITH FACTORY KNOCKOUTS.
- ALL WIRES SHALL BE COPPER AND THERMOPLASTIC INSULATED TYPE "THW" UNLESS OTHERWISE INDICATED IN THE PLAN. THE MINIMUM SIZE OF WIRE FOR POWER AND LIGHTING CIRCUIT HOMERUN SHALL BE 3.5mm² AND INSULATED FOR 600 VOLTS. SMALLEST RAYWAY SHALL BE 15mm² TRADE/NOMINAL SIZE 1.
- GROUNDING SYSTEM SHALL BE PROVIDED TO ALL LIGHTING AND POWER CIRCUIT AS PER PHILIPPINE ELECTRICAL CODE REQUIREMENT.
- MOUNTING HEIGHT OF WIRING DEVICES SHALL BE AS FOLLOWS:
A. CONVENIENCE OUTLET - 0.30 M ABOVE FINISH FLOOR
B. PANELBOARD - 1.50 M ABOVE FINISH FLOOR

USE OF FEEDER CONDUCTOR AND PROTECTION

CONDUCTOR
TOTAL = (6.61)(80%)
= 5.29 AMP

SIZE OF FEEDER PROTECTION

USE 2-5.5mm² THWN COPPER WIRE IN 25mm Ø RSC PIPE
MAIN PROTECTION USE 2P, 20AT, 240V, 60Hz, CB

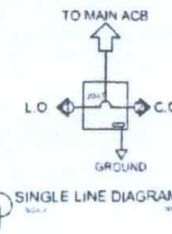
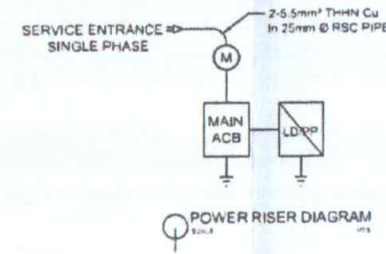
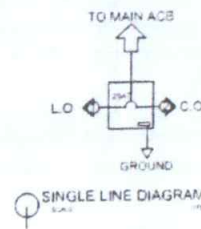
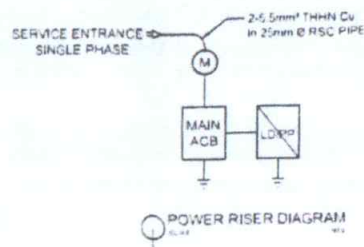

| PREPARED FROM THE OFFICE OF THE: | PROJECT TITLE | PREPARED BY | CHECKED & REVIEWED BY | RECOMMENDING APPROVAL | APPROVED | SHEET CONTENTS | SHEET NO. |
|--|--|---|--------------------------------------|---|---|----------------|-----------|
| REPUBLIC OF THE PHILIPPINES DEPARTMENT OF AGRICULTURE REGIONAL FIELD OFFICE I AGRI-1000, ANTONIO M. LUNA AVENUE, LAGUNA | CONSTRUCTION OF PERIMETER FENCE WITH GATE, WAITING SHED AND GUARDHOUSE | EDEN RUTH S. INES, ABE TECHNICAL STAFF | MARK HARRY M. PASTOR, ABE OFFICER | DENNIS P. TACTAG, ABE RISER OPERATIONS | JOHN B. PASCUAL, DVM DIST. REGIONAL EXECUTIVE DIRECTOR | AS SHOWN | 7 7 |

PROJECT TITLE : CONSTRUCTION OF PERIMETER FENCE WITH GATE, WAITING SHED AND GUARD HOUSE

PROJECT LOCATION: DA-ISReC, SAN JUAN, ILOCOS SUR

GENERAL SPECIFICATIONS

General Conditions - All parts of the construction must comply with the satisfaction and approval of the Architect/Engineer and the Owner.

Improvement shall conform with all the requirements of the National Building Code, as well as the local rules and regulations of the Municipality of San Juan, Ilocos Sur.

I. MOBILIZATION & DEMOBILIZATION 1.00 l.s

The Contractor shall provide all labor and equipment costs necessary to move personnel, equipment, supplies and incidentals to and from the Project Site, establish offices, buildings and other facilities necessary for the Work, obtain bonds, required insurance and any other pre-construction expenses necessary to perform the Work. This section shall exclude the cost of construction materials.

II. CONSTRUCTION AND HEALTH STANDARD 1.00 l.s

- ◆ Provide project billboard that conforms with COA Circular No.2013-004 "Information and Publicity on Programs/Projects/Activities of Government Agencies;"
- ◆ Must comply with Construction Safety and Health (DOLE order # 13 series of 1998).
- ◆ Provide all workers the necessary equipment (PPE) for the eyes, face, feet and all crucial body parts exposed to hazardous work procedures;
- ◆ Ensure that all workers must be oriented, instructed and trained by the construction project manager to assure safe handling of equipment and disposing waste;
- ◆ Provide one (1) safety officer;
- ◆ Provide one (1) first aid facility with medicinal kits;
- ◆ Provide safety signage's (I.e., signboards, barricades, etc.);
- ◆ Provide facilities for workers with adequate drinking water, sanitary facilities; and
- ◆ Provide all labor and equipment costs necessary to move personnel, equipment, supplies and incidentals to and from the project site.

III. TEMPORARY FACILITY 12.00 sq.m

Contractor shall provide, erect, install, maintain, alter as necessary, and remove on completion or when directed by the Engineer, temporary facilities and as described or specified in this section.

IV. PROJECT BILLBOARD & PERMIT 1.00 lot

- ◆ Billboard must now follow a standard design, dimension, and letter sizes on a white background and measure 1220mm x 2440mm;
- ◆ Billboards must be installed in front of the projects.
- ◆ Before erecting a fence, Contractor shall coordinate with the property owner or end-user for necessary documents needed in securing necessary permits such as Cutting Permit and Fencing Permit and approvals from the local government unit (LGU) or barangay where the property is located. Failure to obtain these permits can result in penalties or even the removal of the fence.
- ◆ Setbacks with a minimum of distance from the property line or any other structures.

V. CLEARING AND GRUBBING

477.47 sq.m

- ◆ This item shall consist of clearing, removing and disposing all unnecessary materials, vegetation and debris as designed in the Contract, except those objects that are designated to remain in the place or are to be removed in consonance with other provisions of this Specification. The work shall also include the preservation from injury or defacement of all objects designated to remain, and
- ◆ The Engineer will establish the limit of work and designate all trees, shrubs, plants and other things to remain. The Contractor shall preserve all objects designated to remain.

VI. DEMOLITION WORKS

1.00 lot

This item includes demolition of existing perimeter fence and structures that causes obstruction. Limitation of work will establish by the End-user and Contractor shall preserve all objects or structure designated to remain.

VII. EARTHWORKS

178.00 cu.m

- ◆ Works are directed to be performed by the Contractor but are not specified in the specification, the Contractor shall carry them out with full diligence and expedience as are expected for works of this nature under the obligations of the Contractor,
- ◆ The Contractor shall allow in his contract price for his compliance with the requirements of this section and for all other things necessary to complete the required earthworks, and
- ◆ The Contractor's compliance with the statutory limits shall not relieve him of his sole responsibility for all consequential damages to adjoining structures, roads and other properties caused by excavation work.

VIII. RSB WORKS

9,266.14 kg

- ◆ Unless otherwise shown on plans, reinforcing steel shall be deformed bars, standard size, and in accordance with the metal reinforcement and requirements of standard specifications for concrete, weldable and reinforced concrete; and
- ◆ Contractor shall submit material testing result as required.

IX. FORM WORKS

356.01 sq.m

- ◆ Form works to be use should be rigid, watertight, braced and tied together to maintain position and shape during construction,
- ◆ Able to be removed easily and safety without damaging the formed concrete, or have components that remain as part of the finished structure so the rest can be removed without damaging the structure, and
- ◆ Shall be sound, good quality lumber, free from large loose knots and shall be not less than 1/2" thick plywood, or boards of even thickness.

X. CONCRETE WORKS

199.19 cu.m

- ◆ All concrete work shall be done in accordance with standard "specification for government reinforced concrete" as adopted by the government in so far as it does not conflict with the specific provisions specified herein for "concrete masonry works" and the revised proportioning of concrete as specified hereinafter; and
- ◆ Contractor shall submit material testing result as required.

XI. MASONRY WORKS

732.60 sq.m

- ◆ For walls and partitions shown in the drawing requiring concrete hollow blocks, use approved machine locally made 5" hollow blocks,
- ◆ Reinforcing bars shall be based on plans. All horizontal reinforcement must be tied to the vertical reinforcement at their intersection. All horizontal reinforcement must be placed at every three layers of hollow blocks and tied to the vertical reinforcement at 0.60m on centers at their intersections,
- ◆ All exposed walls and concrete should be properly plaster with not less than 16mm.

XII. STEEL WORKS

1.00 lot

- ◆ All other materials specifically indicated and illustrated on plans to be installed and improve shall be taken as part of this specification regardless whether or not written and the end user shall approve such other materials before they are set in place.

The materials to be used are the following:

| | |
|-----------------------------|--------------------------|
| 2"x4"x1.5mm Tubular | Welding Rod |
| 2"x2"x1.5mm Tubular | Cutting Dics |
| 1 1/2"x1 1/2"x1.2mm Tubular | Grinding Stone |
| 250mmx125mm I-Beam | MS Plate 10mmx1mx1m |
| 2" x 2" x 3/16 Angle bar | Sliding Door Accessories |
| Plain Sheet | 16mm Anchor Bolt |
| Square Bar 1" x 1" | Boom Gate |
| 1" x 3/16 Flat Bar | |

XIII. PAINTING WORKS

732.60 sq.m

- ◆ All painting works for this project, except as hereinafter specified, shall be done with the use of paint products,
- ◆ Before any painting is done, all surface shall be cleaned, smoothed and freed from dust, dirt, grease, mortar, rust and other foreign substances. All parts where paint remover has been used shall be washed off with paint or lacquer thinner. All paints shall be spread evenly and carefully,
- ◆ Contractor shall check all welded steel and metals free from debris and sharp edged;
- ◆ All metals should be properly paint by the Contractor with epoxy primer twice before welding and fabrication and apply two (2) coatings of QDE,
- ◆ After installation, retouch should be done,
- ◆ Application of neutralizer for concrete and skimcoat before application of primer (2 coatings) and semi-gloss latex for final coating (2 Coatings),
- ◆ Upon completion of the painting works, the painting Contractor shall remove any paint spots from all finished work. He shall present his work to the in charge of the construction, free from blemishes and rubbish generated by his workers.

XIV. ROOFING WORKS

1.00 lot

- ◆ The roofing contractor shall supply all labor, tools, staging and equipment necessary and shall perform all finishing work as shown in the schedule of roofing work for this project. The roofing contractor shall store his materials in one place in the building to be kept near and clean to prevent accident.
- ◆ Upon completion of the roofing works, the roofing Contractor shall remove any debris from all finished work. He shall present his work to the in charge of the construction, free from blemishes and rubbish generated by his workers.
- ◆ It shall be the roofing Contractor's responsibility to protect his work and those of other Contractors during the time his work is underway. He shall be responsible for any damage to the work or property of others caused by his employees or by himself.
- ◆ After installation is done, make sure it was properly sealed for any entry of water to prevent leakage, all surface shall be cleaned, smoothed and freed from dust, dirt, grease, mortar, rust and other foreign substances.
- ◆ All other materials specifically indicated and illustrated on plans shall be taken as part of this specification regardless whether or not written and the end user shall approve such other materials before they are set in place.

The materials to be used are the following:

| | |
|---|---|
| <i>2"x10" C-Purlins</i> | <i>Rib Spandrel in Pre-Painted Finish</i> |
| <i>2"x3" C-Purlins</i> | <i>Downspout 2"</i> |
| <i>0.5mm Pre-painted long span rib-type roofing</i> | <i>Texscrew</i> |
| <i>8" Pre-painted Box End Flashing</i> | <i>Blind Rivet</i> |
| <i>8" Pre-painted Box Gutter</i> | <i>Drill bit</i> |
| <i>8" Pre-painted Fascia Cover</i> | |

XV. ELECTRICAL WORKS

15.00 outlets

- ◆ All electrical works shall comply in accordance with these plans and specifications. The applicable provisions of the latest edition of the Philippine Electrical Code (PEC), and
- ◆ The rules and regulations of the Local Enforcing Authority and the requirements of the Local Power Company. The electrical works shall be done under the immediate supervision of a duly Registered Electrical Engineer.

XVI. DOORS & WINDOWS

10.86 sq.m

- ◆ All other materials specifically indicated and illustrated on plans to be installed and improve shall be taken as part of this specification regardless whether or not written and the end user shall approve such other materials before they are set in place.

The materials to be used are the following:

| | |
|---|--|
| <i>Aluminum Door w/ jamb and accessories</i> | <i>1.25m x 1.00.m Aluminum Window(Sliding)</i> |
| <i>2.50m x 1.00m Aluminum Window(Fixed glass)</i> | <i>2.50m x 1.00m Aluminum Window(Sliding)</i> |

The above specifications are intended for the **CONSTRUCTION OF PERIMETER FENCE WITH GATE, WAITING SHED AND GUARD HOUSE AT DA-ISReC, SAN JUAN, ILOCOS SUR**

Prepared and Submitted by:



EDEN RUTH S. INES, ABE

Technical Staff, EPDSS

Checked and Reviewed by:



MARK HARRY G. PASTOR, ABE

Chief, RAED

DEPARTMENT OF AGRICULTURE-REGIONAL FIELD OFFICE 1
NAME OF PROCURING ENTITY

PROJECT REFERENCE NO.: _____
 NAME OF PROJECT: _____

**STATEMENT OF ALL ON-GOING GOVERNMENT AND PRIVATE CONTRACTS, INCLUDING CONTRACTS AWARDED BUT NOT YET
 STARTED, IF ANY, WHETHER SIMILAR OR NOT SIMILAR IN NATURE AND COMPLEXITY TO THE CONTRACT TO BE BID**

CONTRACT TO BE BID: _____
BUSINESS NAME: _____
BUSINESS ADDRESS: _____

| Name of Contract/ Location Project Cost | a. Owner's Name b. Address c. Telephone Nos. | NATURE OF WORK | CONTRACTOR'S ROLE | | a. Date Awarded b. Date Started c. Date Completion | % Accomplishment | | Value of Outstanding Works |
|--|--|-------------------|-------------------|---|--|---------------------|--------|-------------------------------|
| | | | Description | % | | Planned | Actual | |
| | | | | | | | | |
| | | | | | | | | |
| | | | | | | | | |
| | | | | | | | | |
| | | | | | | | | |
| | | | | | | | | |

Note: This statement shall be supported with:
 1. Notice of Award and/or Contract
 2. Notice to Proceed issued by the Owner

Submitted by:

Name of Representative of Bidder
Position
 Date: _____

Statement identifying the Bidder's Single Largest Completed Contract (SLCC) similar in nature

Contract to be Bid: _____
 Business Name: _____
 Business Address: _____

| Name of Client | a. Owner's Name b. Address c. Telephone Nos. | Title of the Project in the Contract | Nature of Work | a. Date Awarded b. Contract Effectivity c. Date Completed | Contractor's Role (whether sole contractor, subcontractor, or partner in a JV) | | a. Total Contract Value at Award b. Total Contract Value at Completion c. Contract Duration |
|-------------------|--|---|-------------------|---|---|---|---|
| | | | | | Description | % | |
| <u>Government</u> | | | | | | | |
| | | | | | | | |
| | | | | | | | |
| | | | | | | | |
| <u>Private</u> | | | | | | | |
| | | | | | | | |
| | | | | | | | |
| | | | | | | | |

Note: This statement shall be supported with:

1. Notice of Award
2. Notice to Proceed
3. Contract
4. Owner's Certificate of Acceptance OR Constructors Performance Evaluation Summary (CPES) Rating

Submitted by : _____
 (Printed Name and Signature)
 Designation : _____
 Date : _____

Bid Securing Declaration Form

[shall be submitted with the Bid if bidder opts to provide this form of bid security]

REPUBLIC OF THE PHILIPPINES)
CITY OF _____) S.S.

BID SECURING DECLARATION **Project Identification No.: *[Insert number]***

To: **DEPARTMENT OF AGRICULTURE REGIONAL FIELD OFFICE 1**
City of San Fernando, La Union

I/We, the undersigned, declare that:

1. I/We understand that, according to your conditions, bids must be supported by a Bid Security, which may be in the form of a Bid Securing Declaration.
2. I/We accept that: (a) I/we will be automatically disqualified from bidding for any procurement contract with any procuring entity for a period of two (2) years upon receipt of your Blacklisting Order; and, (b) I/we will pay the applicable fine provided under Section 6 of the Guidelines on the Use of Bid Securing Declaration, within fifteen (15) days from receipt of the written demand by the procuring entity for the commission of acts resulting to the enforcement of the bid securing declaration under Sections 23.1(b), 34.2, 40.1 and 69.1, except 69.1(f), of the IRR of RA No. 9184; without prejudice to other legal action the government may undertake.
3. I/We understand that this Bid Securing Declaration shall cease to be valid on the following circumstances:
 - a. Upon expiration of the bid validity period, or any extension thereof pursuant to your request;
 - b. I am/we are declared ineligible or post-disqualified upon receipt of your notice to such effect, and (i) I/we failed to timely file a request for reconsideration or (ii) I/we filed a waiver to avail of said right; and
 - c. I am/we are declared the bidder with the Lowest Calculated Responsive Bid, and I/we have furnished the performance security and signed the Contract.

IN WITNESS WHEREOF, I/We have hereunto set my/our hand/s this ____ day of *[month]* *[year]* at *[place of execution]*.

[Insert NAME OF BIDDER OR ITS AUTHORIZED REPRESENTATIVE

[Insert signatory's legal capacity]

Affiant

[Jurat]

[Format shall be based on the latest Rules on Notarial Practice]

DEPARTMENT OF AGRICULTURE-REGIONAL FIELD OFFICE 1

NAME OF PROCURING ENTITY _____

Standard Form Number: SF-INFR-48
 Revised on: August 11, 2004

Contract Reference No.: _____

Name of the Contract: _____

Location of the Contract: _____

(LIST) Qualification of Key Personnel Proposed to be Assigned to the Contract

Business Name: _____

Business Address: _____

| | | Project Manager/Engineer | Materials Engineer | Foreman | Construction Safety and Health Personnel | Other positions deemed required by the Applicant for the project |
|---|---------------------|--------------------------|--------------------|---------|--|--|
| 1 | Name | | | | | |
| 2 | Address | | | | | |
| 3 | Date of Birth | | | | | |
| 4 | Employed since | | | | | |
| 5 | Experience | | | | | |
| 6 | Previous Employment | | | | | |
| 7 | Education | | | | | |
| 8 | PRC Licence | | | | | |

Minimum Requirements : Project Manager/Engineer
 : Materials Engineer
 : Foreman
 : Foreman

Note : Attached individual resume and PRC License of the (professional) personnel

Submitted by : _____
 (Printed Name and Signature)

Designation : _____

Date : _____

One of the requirements from the bidder to be included in its Technical Envelope is a list of contractor's key personnel (viz, Project Manager, Project Engineers, Materials Engineers and Foremen), to be assigned to the contract to be bid, with their complete qualification and experience data (including the key personnel signed written commitment to work for the project once awarded the contract).

DEPARTMENT OF AGRICULTURE-REGIONAL FIELD OFFICE 1
NAME OF PROCURING ENTITY

Contract Reference Number
Name of the Contract
Location of the Contract

- 1. Name : _____
- 2. Name and Address of Owner : _____
- 3. Name and Address of the Owner's Engineer (Consultant) : _____
- 3-4. Indicate the Features of Project (particulars of the project Components and any other particular Interest connected with the project): _____
- 5. Contract Amount Expressed in Philippine currency : _____
- 6. Position : _____
- 7. Structures for which the employee was responsible : _____
- 8. Assignment Period : from _____ (months)
: to _____ (months)

Name and Signature of Employee

It is hereby certified that the above personnel can be assigned to this project, if the contract is awarded to our company.

(Place and Date)

(The Authorized Representative)

One of the requirements from the bidder to be included in its Technical Envelope is a list of contractor's key personnel (viz, Project Manager, Project Engineers, Materials Engineers and Foremen), to be assigned to the contract to be bid, with their complete qualification and experience data (including the key personnel signed written commitment to work for the project once awarded the contract). _____ **SF-INFR-47b**

Standard Form Number: SF-INFR-47
Revised on: August 11, 2004

KEY PERSONNEL
(FORMAT OF BIO-DATA)

Give the detailed information of the following personnel who are to be assigned as full-time field staff for the project. Fill up a form for each person.

- Authorized Managing Officer/Representative
- Sustained Technical Employee

1. Name : _____
2. Date of Birth : _____
3. Nationality : _____
4. Education and Degrees : _____
5. Specialty : _____
6. Registration : _____
7. Length of service with the Firm : _____
8. Years of Experience : _____

9. If item 7 is less than ten (10) years, give name and length of service with previous employers for a ten (10)-year period (attach additional sheet/s), if necessary:

| <u>Name and Address of employer</u> | <u>Length of Service</u> |
|-------------------------------------|-----------------------------------|
| _____ | _____ year(s) from _____ to _____ |
| _____ | _____ year(s) from _____ to _____ |
| _____ | _____ year(s) from _____ to _____ |

10. Experience:

This should cover the past ten (10) years of experience. (Attach as many pages as necessary to show involvement of personnel in projects using the format below).

One of the requirements from the bidder to be included in its Technical Envelope is a list of contractor's key personnel (viz, Project Manager, Project Engineers, Materials Engineers and Foremen), to be assigned to the contract to be bid, with their complete qualification and experience data (including the key personnel signed written commitment to work for the project once awarded the contract). _____ SF-INFR-47a

DEPARTMENT OF AGRICULTURE-REGIONAL FIELD OFFICE 1
NAME OF PROCURING ENTITY

Contract Reference Number
Name of the Contract
Location of the Contract

Standard Form Number: SF-INFR-46
Revised on: August 11, 2004

Key Personnel's Certificate of Employment

Issuance Date

DIR. NESTOR

Position of the Head of the Procuring Entity

DEPARTMENT OF AGRICULTURE REGIONAL FIELD OFFICE 1

CITY OF SAN FERNANDO, LA UNIONO

Dear Sir/Madame:

I am (Name of Nominee) a Licensed _____ Engineer with Professional License No. _____ issued on (Date of Issuance) at (place of issuance).

I hereby certify that (Name of Bidder) has engaged my services as (designation) for (name of the Contract), if awarded to it.

As (designation), I supervised the following completed projects similar to the contract under bidding:

| NAME OF PROJECT | OWNER | COST | DATE COMPLETED |
|-----------------|-------|-------|----------------|
| _____ | _____ | _____ | _____ |
| _____ | _____ | _____ | _____ |
| _____ | _____ | _____ | _____ |
| _____ | _____ | _____ | _____ |

At present, I am supervising the following projects:

| NAME OF PROJECT | OWNER | COST | DATE COMPLETED |
|-----------------|-------|-------|----------------|
| _____ | _____ | _____ | _____ |
| _____ | _____ | _____ | _____ |
| _____ | _____ | _____ | _____ |
| _____ | _____ | _____ | _____ |

In case of my separation for any reason whatsoever from the above-mentioned contractor, I shall notify the (Name of the Procuring Entity) at least twenty one (21) days before the effective date of my separation.

As (Designation), I know I will have to stay in the job site all the time to supervise and manage the Contract works to the best of my ability, and aware that I am authorized to hanle only one (1) contract at a time.

I do not allow the use of my name for the purpose of enabling the above-mentioned Contractor to qualify for the Contract without any firm commitment on my part to assume the post of (Designation) thereof, if the contract is awarded to him since I understand that to do so will be

a sufficient ground for my disqualification as (Designation) in any future (Name of the Procuring Entity) bidding or employment with any Contractor doing business with the Name of the Procuring Entity .

(Signature of Engineer)

DRY SEAL

Republic of the Philippines)
_____) S.S.

SUBSCRIBED AND SWORN TO before me this _____ day of _____ 2022 affiant exhibiting to me his/her Residence Certificate No. _____ issued on _____ at _____.

Notary Public
Until December 31, 20_____

Doc. No. _____
Page No. _____
Book No. _____
Series of _____

One of the requirements from the bidder to be included in its Technical Envelope is a list of contractor's key personnel (viz, Project Manager, Project Engineers, Materials Engineers and Foremen), to be assigned to the contract to be bid, with their complete qualification and experience data (including the key personnel signed written commitment to work for the project once awarded the contract). _____ SF-INFR-46a

Standard Form Number: SF-INFR-49

Revised on August 11, 2004

LIST OF EQUIPMENT, OWNED OF LEASED and/or under PURCHASE AGREEMENT, PLEDGED TO THE PROPOSED PROJECT

Business Name : _____

Business Address : _____

| Description | Model/Year | Capacity/ Performance/ Size | Plate No. | Motor No./ Body No. | Location | Condition | Proof of Ownership/ Lessor or Vendor |
|-------------|------------|-----------------------------------|-----------|------------------------|----------|-----------|--|
| | | | | | | | |
| | | | | | | | |
| | | | | | | | |
| | | | | | | | |

List of minimum equipment required for the project

Submitted by : _____

(Print name and affix signature)

Designation : _____

Date : _____

Omnibus Sworn Statement (Revised)

[shall be submitted with the Bid]

REPUBLIC OF THE PHILIPPINES)
CITY/MUNICIPALITY OF _____) S.S.

AFFIDAVIT

I, [Name of Affiant], of legal age, [Civil Status], [Nationality], and residing at [Address of Affiant], after having been duly sworn in accordance with law, do hereby depose and state that:

1. *[Select one, delete the other:]*

[If a sole proprietorship:] I am the sole proprietor or authorized representative of [Name of Bidder] with office address at [address of Bidder];

[If a partnership, corporation, cooperative, or joint venture:] I am the duly authorized and designated representative of [Name of Bidder] with office address at [address of Bidder];

2. *[Select one, delete the other:]*

[If a sole proprietorship:] As the owner and sole proprietor, or authorized representative of [Name of Bidder], I have full power and authority to do, execute and perform any and all acts necessary to participate, submit the bid, and to sign and execute the ensuing contract for [Name of the Project] of the [Name of the Procuring Entity], as shown in the attached duly notarized Special Power of Attorney;

[If a partnership, corporation, cooperative, or joint venture:] I am granted full power and authority to do, execute and perform any and all acts necessary to participate, submit the bid, and to sign and execute the ensuing contract for [Name of the Project] of the [Name of the Procuring Entity], as shown in the attached [state title of attached document showing proof of authorization (e.g., duly notarized Secretary's Certificate, Board/Partnership Resolution, or Special Power of Attorney, whichever is applicable)];

3. [Name of Bidder] is not "blacklisted" or barred from bidding by the Government of the Philippines or any of its agencies, offices, corporations, or Local Government Units, foreign government/foreign or international financing institution whose blacklisting rules have been recognized by the Government Procurement Policy Board, **by itself or by relation, membership, association, affiliation, or controlling interest with another blacklisted person or entity as defined and provided for in the Uniform Guidelines on Blacklisting;**

4. Each of the documents submitted in satisfaction of the bidding requirements is an authentic copy of the original, complete, and all statements and information provided therein are true and correct;

5. [Name of Bidder] is authorizing the Head of the Procuring Entity or its duly authorized representative(s) to verify all the documents submitted;

6. *[Select one, delete the rest:]*

[If a sole proprietorship:] The owner or sole proprietor is not related to the Head of the Procuring Entity, members of the Bids and Awards Committee (BAC), the

Technical Working Group, and the BAC Secretariat, the head of the Project Management Office or the end-user unit, and the project consultants by consanguinity or affinity up to the third civil degree;

[If a partnership or cooperative] None of the officers and members of [Name of Bidder] is related to the Head of the Procuring Entity, members of the Bids and Awards Committee (BAC), the Technical Working Group, and the BAC Secretariat, the head of the Project Management Office or the end-user unit, and the project consultants by consanguinity or affinity up to the third civil degree;

7. *[Name of Bidder]* complies with existing labor laws and standards; and
8. *[Name of Bidder]* is aware of and has undertaken the responsibilities as a Bidder in compliance with the Philippine Bidding Documents, which includes:
 - a. Carefully examining all of the Bidding Documents;
 - b. Acknowledging all conditions, local or otherwise, affecting the implementation of the Contract;
 - c. Making an estimate of the facilities available and needed for the contract to be bid, if any; and
 - d. Inquiring or securing Supplemental/Bid Bulletin(s) issued for the *[Name of the Project]*.
9. *[Name of Bidder]* did not give or pay directly or indirectly, any commission, amount, fee, or any form of consideration, pecuniary or otherwise, to any person or official, personnel or representative of the government in relation to any procurement project or activity.
10. **In case advance payment was made or given, failure to perform or deliver any of the obligations and undertakings in the contract shall be sufficient grounds to constitute criminal liability for Swindling (Estafa) or the commission of fraud with unfaithfulness or abuse of confidence through misappropriating or converting any payment received by a person or entity under an obligation involving the duty to deliver certain goods or services, to the prejudice of the public and the government of the Philippines pursuant to Article 315 of Act No. 3815 s. 1930, as amended, or the Revised Penal Code.**

IN WITNESS WHEREOF, I have hereunto set my hand this ___ day of ___, 20__ at _____, Philippines.

[Insert NAME OF BIDDER OR ITS AUTHORIZED REPRESENTATIVE]

[Insert signatory's legal capacity]

Affiant

[Jurat]

[Format shall be based on the latest Rules on Notarial Practice]

COMPUTATION OF NET FINANCIAL CONTRACTING CAPACITY (NFCC)

Summary of the Applicant Supplier's/Distributor's assets and liabilities on the basis of the attached Income Tax Return and Audited Financial Statement, stamped "RECEIVED" by the Bureau of Internal Revenue or BIR authorized collecting agent for the immediately preceding year.

| | | Year 20__ |
|---|---------------------------|-----------|
| 1 | Total Assets | |
| 2 | Current Assets | |
| 3 | Total Liabilities | |
| 4 | Current Liabilities | |
| 5 | Net Worth (1-3) | |
| 6 | Net Working Capital (2-4) | |

The Net Financial Contracting Capacity (NFCC), which must be at least equal to the ABC to be bid, based on the above data is calculated as follows:

NFCC = [(Current asset minus current liabilities) (15)] minus the value of all outstanding or uncompleted portions of the projects under ongoing contracts, including awarded contracts yet to be started

Or,

If the prospective bidder opts to submit a Committed Line of Credit (CLC), it must be at least equal to ten percent (10%) of the ABC to be bid and shall be confirmed or authenticated by a local universal or commercial bank.

Name of Bank _____ Amount _____

Herewith attached are certified true copies of the Income Tax Return and Audited Financial Statement Stamped "RECEIVED" by the BIR authorized collecting agent for the immediately preceding year.

Submitted by:

Name of Supplier/Distributor/Manufacturer

Printed Name and Signature of Authorized Representative

Date:

Bid Form for the Procurement of Infrastructure Projects

[shall be submitted with the Bid]

BID FORM

Date: _____
Project Identification No.: _____

To: **DEPARTMENT OF AGRICULTURE REGIONAL FIELD OFFICE 1**
City of San Fernando, La Union

Having examined the Philippine Bidding Documents (PBDs) including the Supplemental or Bid Bulletin Numbers [insert numbers], the receipt of which is hereby duly acknowledged, we, the undersigned, declare that:

- a. We have no reservation to the PBDs, including the Supplemental or Bid Bulletins, for the Procurement Project: *[insert name of contract]*;
- b. We offer to execute the Works for this Contract in accordance with the PBDs;
- c. The total price of our Bid in words and figures, excluding any discounts offered below is: *[insert information]*;
- d. The discounts offered and the methodology for their application are: *[insert information]*;
- e. The total bid price includes the cost of all taxes, such as, but not limited to: *[specify the applicable taxes, e.g. (i) value added tax (VAT), (ii) income tax, (iii) local taxes, and (iv) other fiscal levies and duties]*, which are itemized herein and reflected in the detailed estimates,
- f. Our Bid shall be valid within the period stated in the PBDs, and it shall remain binding upon us at any time before the expiration of that period;
- g. If our Bid is accepted, we commit to obtain a Performance Security in the amount of *[insert percentage amount]* percent of the Contract Price for the due performance of the Contract, or a Performance Securing Declaration in lieu of the allowable forms of Performance Security, subject to the terms and conditions of issued GPPB guidelines¹² for this purpose;
- h. We are not participating, as Bidders, in more than one Bid in this bidding process, other than alternative offers in accordance with the Bidding Documents;
- i. We understand that this Bid, together with your written acceptance thereof included in your notification of award, shall constitute a binding contract between us, until a formal Contract is prepared and executed; and
- j. We understand that you are not bound to accept the Lowest Calculated Bid or any other Bid that you may receive.

- k. We likewise certify/confirm that the undersigned, is the duly authorized representative of the bidder, and granted full power and authority to do, execute and perform any and all acts necessary to participate, submit the bid, and to sign and execute the ensuing contract for the *[Name of Project]* of the *[Name of the Procuring Entity]*.

- l. We acknowledge that failure to sign each and every page of this Bid Form, including the Bill of Quantities, shall be a ground for the rejection of our bid.

Name: _____

Legal capacity: _____

Signature: _____

Duly authorized to sign the Bid for and behalf of: _____

Date: _____